

DÜNYA DÜZDÜR, BİR ADIM YETER!
EARTH IS FLAT, ONE STEP IS ENOUGH!

ake

04 - 49

ASANSÖR SİSTEMLERİ
ELEVATOR SYSTEMS

50 - 59

YÜRÜYEN MERDİVEN VE BANT SİSTEMLERİ
ESCALATOR AND MOVING WALKWAY SYSTEMS

60 - 73

ENGELLİ SİSTEMLERİ
DISABLED SYSTEMS

74 - 81

ÖZEL ÇÖZÜMLER
SPECIAL SOLUTIONS

82 - 83

AKE ASSISTANCE TEKNİK SERVİS
AKE ASSISTANCE TECHNICAL SERVICE



20. YILINDA, AKE...

1995 yılında kurulduğumuz günden itibaren, sorumluluğunu üstlendiğimiz her projede “üretken, çözümcü ve sürdürülebilir” olmayı ilke edindik. Ülke menfaatlerimizi gözeterek sektörümüzdeki ihracatımızı maksimum seviyeye taşımamızın önemini düşünerek çalışıyoruz.

Önümüzdeki yıllar için de net hedeflerimiz var. AKE kültürünü yansıtan inovatif ürün ve hizmetlerimizle her geçen yıl daha fazla kullanıcının tercihi olmak, üretim birimlerimizi ve istihdamımızı katlayarak artırmak... Ve elbette hedefimize ulaşmak için ihtiyaç duyduğumuz gücün, işçisinden mühendisine, bayisinden satış elemanına kadar AKE bayrağı altında birleşen herkesin akıllarında ve yüreklerinde olduğunu biliyoruz. İşte bu güce olan inancımızla, geleceğe büyük bir umut ile bakıyoruz. AKE’yi Türk asansör sektörünün lokomotifine haline getiren, bu yolda bizimle birlikte yürüyen herkese can-ı gönülden teşekkür ediyor, daha nice yıllarda ve başarılarında hep birlikte olmayı diliyoruz.

Sevgi ve Saygılarımla...

20 YEARS AKE...

Since we established in 1995, we adopted being “productive, solver and sustainable” as a principle in all projects which we took responsibility. We carried out lots of important projects in Turkey with our own production system technologies. Today, we became an ambassador introducing our country’s values as a representative Turkish company not only in our territory but in the whole world.

We have clear-cut aims for the next years... Increasing our number of companies such as piles at the four corners of the earth, being the preference of more people by every passing year with our innovative products and services reflecting AKE culture, incrementally increasing our production units based in our country and employment...And of course, we know that the power we need to reach our aims is in the minds and hearts of all merging under the title of AKE from workers to engineers, from distributor to sales representative. With this faith in this power, we are full of hope for the future. We thank everybody who transformed AKE into locomotive of Turkish elevator sector and walked this path along with us by heart and wish many successful years together.

Sincerely...

Çetin KESKİN

Yönetim Kurulu Başkanı
Chairman

ake



ASANSÖR SİSTEMLERİ ELEVATOR SYSTEMS

*Konforunuz için tasarlandı!
Designed for your comfort!*



ÜRETİMDEKİ ESTETİK ÇİZGİLER PRODUCTION WITH AESTHETIC LINES

AKE kişisel beklentilere uygun kabinler üretir. Bu üretim süreci, iç mimari, resim ve endüstri tasarımı disiplinlerinin neredeyse tümünü içerir.

Bir üretimi birçok şey etkiler; sektörün kazanımı olan yeni malzemeler, yeni ürün ve renkler, doku dengeleri, moda, marka ve kurumsal görsellikler. Tüm estetik yapı, her bütçeye göre ve mühendisliğin gerektirdiği hiçbir detaya engel olmadan gerçekleşir.

AKE produces with aesthetic lines according to the personal expectations. This production process comprehends nearly all types of interior architecture, painting and industrial design.

Lots of things impact on a production; new materials of sectoral gain, new products and colors, texture, balances, fashion, brand and institutional visualizations. Aesthetic structure as a whole, takes shape in according to all types of budgets and without obstacles of engineering requires.

LIMYRA



TAVAN / CEILING

KB 4082

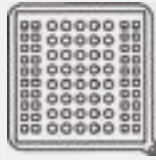

KB 4008



ZEMİN / FLOOR

Mozaik PVC

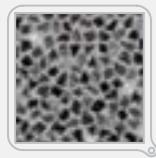

Lapland Quartz



YAN DUVARLAR : PVC Lamine Sac
SIDE WALL PANELS : PVC Laminated Metal

AYDINLATMA : Spot
LIGHTING : Spot

DAMLATAŞ



TAVAN / CEILING

KB 4034

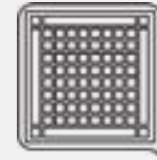

KB 4036



ZEMİN / FLOOR

Roza Porino Granit

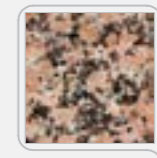

Mozaik PVC



YAN DUVARLAR : PVC Lamine Sac
SIDE WALL PANELS : PVC Laminated Metal

AYDINLATMA : Endirekt
LIGHTING : Indirect

DETAYLAR / DETAILS



DETAYLAR / DETAILS



PHASELIS



TAVAN / CEILING

KB 4018



KB 4072



ZEMİN / FLOOR

Deretaşı PVC



Santiago Red Granit

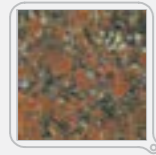

YAN DUVARLAR SIDE WALL PANELS	:	Ahşap Laminat / Vişne Laminated Wooden - PVC / Cherry
AYDINLATMA LIGHTING	:	Spot & Led Spot & Led

ATTALIA



TAVAN / CEILING

KB 4042

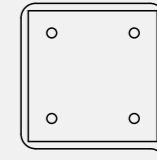

KB 4068

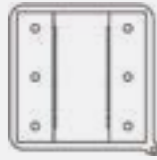

ZEMİN / FLOOR

Porto Roza Granit

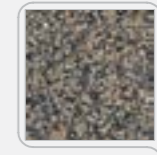

Mozaik PVC

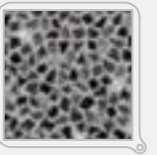

YAN DUVARLAR SIDE WALL PANELS	:	Ahşap Laminat / Vişne Laminated Wooden - PVC / Cherry
AYDINLATMA LIGHTING	:	Endirekt Indirect

DETAYLAR / DETAILS



DETAYLAR / DETAILS



ake

Asansör, Yürüyen Merdiven, Engelli Sistemleri
Elevator, Escalator, Disabled Systems



SYEDRA

KALKAN



TAVAN / CEILING

KB 4004



KB 4025



ZEMİN / FLOOR

Deretaşı PVC



Nero Zimbabwe



YAN DUVARLAR : High Gloss Mdf / Metalik Karaağaç
SIDE WALL PANELS : High Gloss Mdf / Metallic Elm

AYDINLATMA : Endirekt
LIGHTING : Indirect

KAŞ



TAVAN / CEILING

KB 4040



KB 4080



ZEMİN / FLOOR

Roza Porino Granit

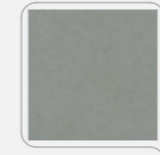

Deretaşı PVC



YAN DUVARLAR : High Gloss Mdf / Avrupa Tik
SIDE WALL PANELS : High Gloss Mdf / European Teak

AYDINLATMA : Endirekt
LIGHTING : Indirect

DETAYLAR / DETAILS



DETAYLAR / DETAILS



KEMER

TAVAN / CEILING

KB 4063



KB 4081



ZEMİN / FLOOR

Deretaşı PVC



Elvas Quartz



YAN DUVARLAR : High Gloss MDF / Abanoz
SIDE WALL PANELS : High Gloss Mdf / Ebony

AYDINLATMA : Spot & Led
LIGHTING : Spot & Led



ALARA

TAVAN / CEILING

KB 4018



KB 4071



ZEMİN / FLOOR

Lapland Quartz



Mozaik PVC

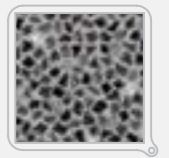

YAN DUVARLAR : Satine Paslanmaz
SIDE WALL PANELS : Stainless Steel / Brushed

AYDINLATMA : Endirekt
LIGHTING : Indirect



DETAYLAR / DETAILS



DETAYLAR / DETAILS





**Bursaray
İstasyonları**
*Bursaray Railway
Station*

AKDENİZ



TAVAN / CEILING

KB 4075



KB 4026

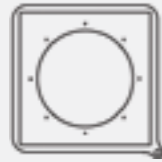

ZEMİN / FLOOR

Star Galaksi Granit



Blue Pearl Granit

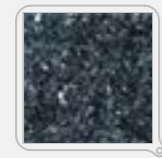

YAN DUVARLAR SIDE WALL PANELS	:	Lamine Opak Cam Laminated Glass / Colored
AYDINLATMA LIGHTING	:	Endirekt Indirect

PATARA



TAVAN / CEILING

KB 4025



KB 4077



ZEMİN / FLOOR

Star Galaksi Granit

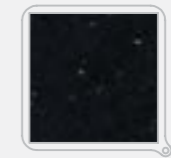

Deretaşı PVC



YAN DUVARLAR SIDE WALL PANELS	:	Lamine Desenli Cam Laminated Figured Glass
AYDINLATMA LIGHTING	:	Spot & Led Spot & Led

DETAYLAR / DETAILS

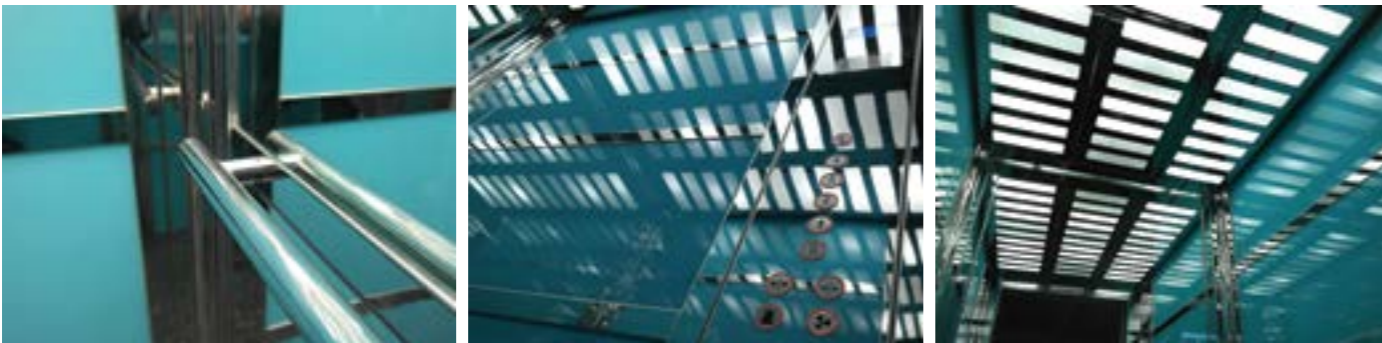

DETAYLAR / DETAILS

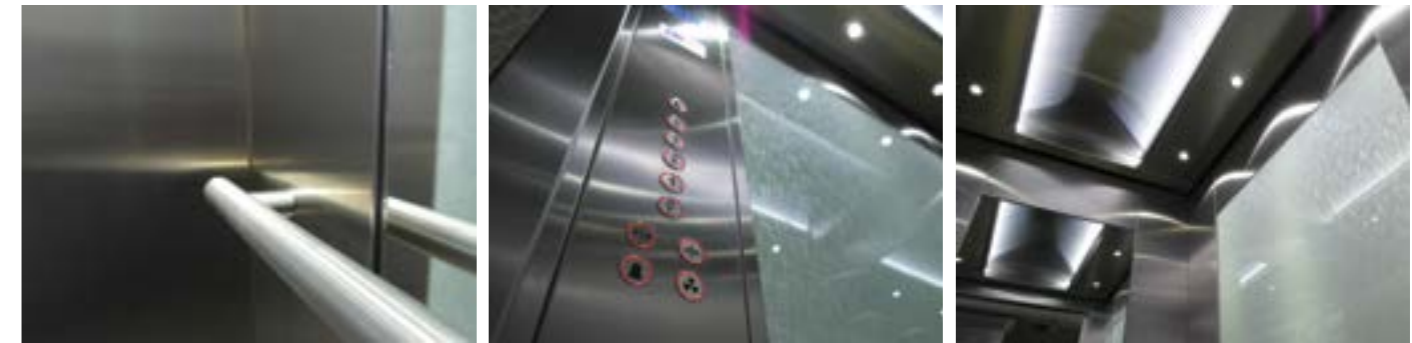

TRIA



TAVAN / CEILING

KB 4068



KB 4026

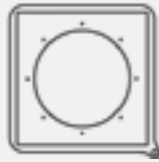

ZEMİN / FLOOR

Star Galaksi Granit



Blue Pearl Granit

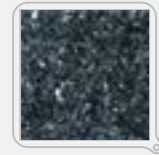

YAN DUVARLAR SIDE WALL PANELS	:	Lamine Opak Cam Laminated Opaque Glass
AYDINLATMA LIGHTING	:	Led Led

OTTOMAN



TAVAN / CEILING

KB 4084

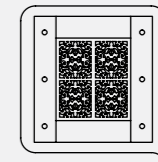

KB 4074



ZEMİN / FLOOR

Savana Quartz



Star Galaksi Granit



YAN DUVARLAR SIDE WALL PANELS	:	Dekoratif Kesim Satine Paslanmaz Decorative Cutting Stainles Steel Satin / Brushed
AYDINLATMA LIGHTING	:	Spot & Led Spot & Led

DETAYLAR / DETAILS



DETAYLAR / DETAILS



ake

Asansör, Yürüyen Merdiven, Engelli Sistemleri
Elevator, Escalator, Disabled Systems



**Vakko
Antalya Mağazası**

*Vakko Antalya
Store*

PNR 01

TAVAN / CEILING

KB 4080



ZEMİN / FLOOR

Star Galaksi Granit



YAN DUVARLAR SIDE WALL PANELS	:	Satine Paslanmaz Stainless Steel / Brushed
AYDINLATMA LIGHTING	:	Spot & Led Spot & Led



PNR 02

TAVAN / CEILING

KB 4063



ZEMİN / FLOOR

Star Galaksi Granit



YAN DUVARLAR SIDE WALL PANELS	:	Dekoratif Desenli Ayna Figured Decorative Mirror
AYDINLATMA LIGHTING	:	Spot & Led Spot & Led



DETAYLAR / DETAILS



DETAYLAR / DETAILS



PNR 03

TAVAN / CEILING

KB 4063



ZEMİN / FLOOR

Star Galaksi Granit



YAN DUVARLAR SIDE WALL PANELS	:	Satine Paslanmaz Stainless Steel / Brushed
AYDINLATMA LIGHTING	:	Spot & Led Spot & Led



DETAYLAR / DETAILS





**Uluslararası
Antalya Üniversitesi**

*International
Antalya University*



SEDYE KABİNİ / STRETCHER LIFT CABIN

TRIA SEDYE

TAVAN / CEILING

KB 4068



KB 4063



ZEMİN / FLOOR

Star Galaksi Granit



Blue Pearl Granit

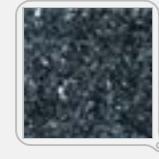

YAN DUVARLAR SIDE WALL PANELS	:	Lamine Opak Cam Laminated Opaque Glass
AYDINLATMA LIGHTING	:	Led Led



DETAYLAR / DETAILS



SERVICE (DUMBWAITER) LIFT CABIN

SERVİS MONŞARJ ASANSÖR KABİNİ

TEKNİK ÖZELLİKLER / TECHNICAL INFORMATION

KABİN TAŞIMA KAPASİTESİ	: Talebe Göre Dizayn ve Üretim Yapılmaktadır
KABİN İÇİ	: Satine Paslanmaz
KAPILAR	: Giyotin-Tip Aşağı ve Yukarı Çift Kanat Açılır
KAPI KAPLAMASI	: Satine Paslanmaz

CARRYING CAPACITY OF CABIN	: Design and Production is Done by Request
CAB(LIFT CAB)	: Stainless Steel Satin / Brushed
DOORS	: Guillotine-Type Double Wing Opens up and Down
DOOR OVERLAY	: Stainless Steel Satin / Brushed



FREIGHT LIFT CABIN

YÜK ASANSÖR KABİNİ

TEKNİK ÖZELLİKLER / TECHNICAL INFORMATION

YAN DUVARLAR	:	Satine Paslanmaz
AYDINLATMA	:	Endirekt
TAVAN	:	Satine Paslanmaz
TABAN	:	Dekoratif PVC

SIDE WALL PANELS	:	Stainless steel / Brushed
LIGHTING	:	Indirect
CEILING	:	Stainless Steel / Brushed
FLOOR	:	Decorative PVC



DETAYLAR / DETAILS



DETAYLAR / DETAILS





MERKEZİ AÇILIR KAPILI YOLCU ASANSÖRÜ
CENTRAL OPENING PASSENGER ELEVATOR

KABİN YÜKÜ / CABIN LOADING	kg/kisi kg/per	CW	CD	SW	SD	DW	A	B	C
	300/4	900	1000	1600	1550	700	300	1000	300
375/5	1100	1000	1800	1550	800	350	1100	350	
450/6	1200	1000	1800	1550	800	350	1100	350	
600/8	1100	1400	1800	1950	800	350	1100	350	
600/8	1100	1400	2000	1950	900	400	1200	400	
750/10	1350	1400	2050	2050	900	425	1200	425	
1000/13	1600	1400	2150	2050	900	475	1200	475	
1000/13	1600	1400	2400	2050	1100	500	1400	500	
1000/13	1100	2100	2300	2500	900	550	1200	550	
1275/16	2000	1400	2500	2100	1100	550	1400	550	
1600/21	2100	1600	2600	2300	1100	600	1400	600	

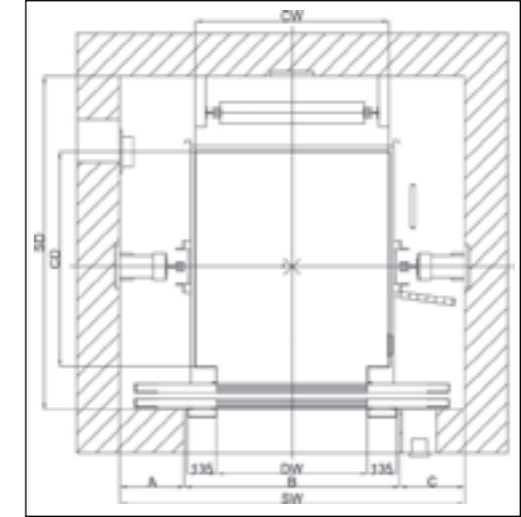

TELESKOPİK AÇILIR KAPILI YOLCU ASANSÖRÜ
TELESCOPIC OPENING PASSENGER ELEVATOR

KABİN YÜKÜ / CABIN LOADING	kg/kisi kg/per	CW	CD	SW	SD	DW	A	B	C
	300/4	900	1000	1500	1600	700	300	1000	200
375/5	1100	1000	1700	1600	800	350	1100	250	
450/6	1200	1000	1750	1600	800	350	1100	300	
600/8	1100	1400	1700	2000	800	350	1100	250	
600/8	1100	1400	1800	2000	900	400	1200	200	
750/10	1350	1400	1950	2100	900	425	1200	325	
1000/13	1600	1400	2150	2100	900	500	1200	450	
1000/13	1600	1400	2250	2100	1100	500	1400	350	
1000/13	1100	2100	1950	2550	900	550	1200	200	
1275/17	2000	1400	2500	2150	1100	550	1400	550	
1600/21	2100	1600	2600	2350	1100	600	1400	600	

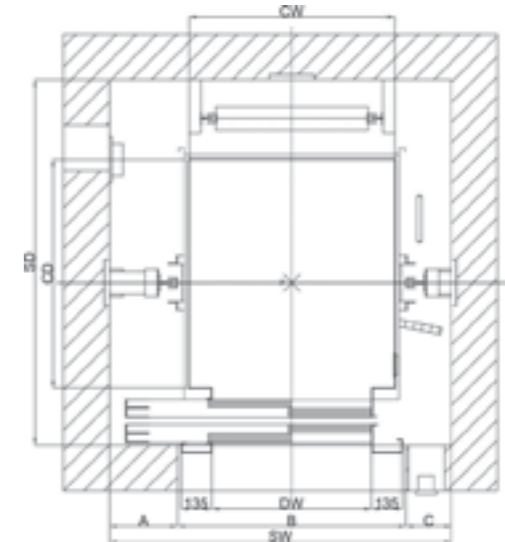

YÜK ASANSÖRÜ
FREIGHT ELEVATOR

KABİN YÜKÜ / CABIN LOADING		CW	CD	SW	SD	DW	A	B	C
kg/kisi kg/per									
1600		1400	2400	2400	2950	1300	600	1600	200
2000		1500	2700	2800	3150	1300	600	1600	600
2500		1800	2700	3000	3150	1300	700	1600	700

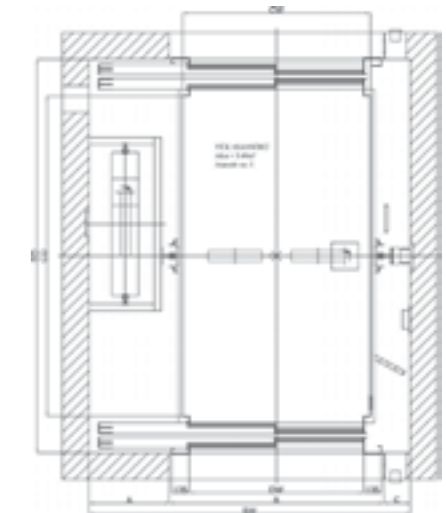

CW → Kabin genişliği Cabin width SD → Kuyu derinliği Shaft depth
CD → Kabin derinliği Cabin depth DW → Kapı genişliği Door width
SW → Kuyu genişliği Shaft width UNIT → mm

ake

Asansör, Yürüyen Merdiven, Engelli Sistemleri
Elevator, Escalator, Disabled Systems



2 PANEL MERKEZİ AÇILIR / 2 PANELS CENTRAL OPENING

2 PANEL TELESKOPİK AÇILIR / 2 PANELS TELESCOPIC OPENING

ÇERÇEVELİ CAMLI

FRAME GLASS



SATİNE PASLANMAZ

STAINLESS STEEL



KOMPLE CAM

FULL GLASS



ÇERÇEVELİ CAMLI

FRAME GLASS



SATİNE PASLANMAZ

STAINLESS STEEL



4 PANEL MERKEZİ AÇILIR / 4 PANELS CENTRAL OPENING

SATİNE PASLANMAZ

STAINLESS STEEL



3 PANEL TELESKOPIK AÇILIR / 3 PANELS TELESCOPIC OPENING

SATİNE PASLANMAZ

STAINLESS STEEL





KABİN BUTONYERLERİ CAR PANELS

→ Özellikler / Features

- Paslanmaz çelik gövde
- Dekoratif paslanmaz seçenekli
- Görme engelliler için uygun tasarım butonlar
- Aşırı yük durumunda ikaz sesi
- LCD, 7 segment gösterge seçenekli
- Laser stainless steel body
- Decorative stainless steel options
- Designed in accordance with the buttons for the visually impaired
- Overload indicator with buzzer
- LCD, 7 segment display options

LCD GÖSTERGELER / LCD DISPLAY



Engelliler İçin Yatay Kabin Kaseti / Horizontal Car Panels for Disabled



BUTON SEÇENEKLERİ / BUTTON OPTIONS



KAT BUTONYERLERİ / LANDING PANELS

GÖSTERGESİZ BUTONYERLER / INDICATOR LESS PANEL



KAPI ÜSTÜ GÖSTERGESİ / POSITION INDICATORS



DİJİTAL SIVA ALTI KAT BUTONYERLERİ / DIGITAL LANDING PANELS



LCD SIVA ALTI KAT BUTONYERLERİ LCD LANDING PANELS



MAKİNE DAİRELİ / MACHINE ROOM

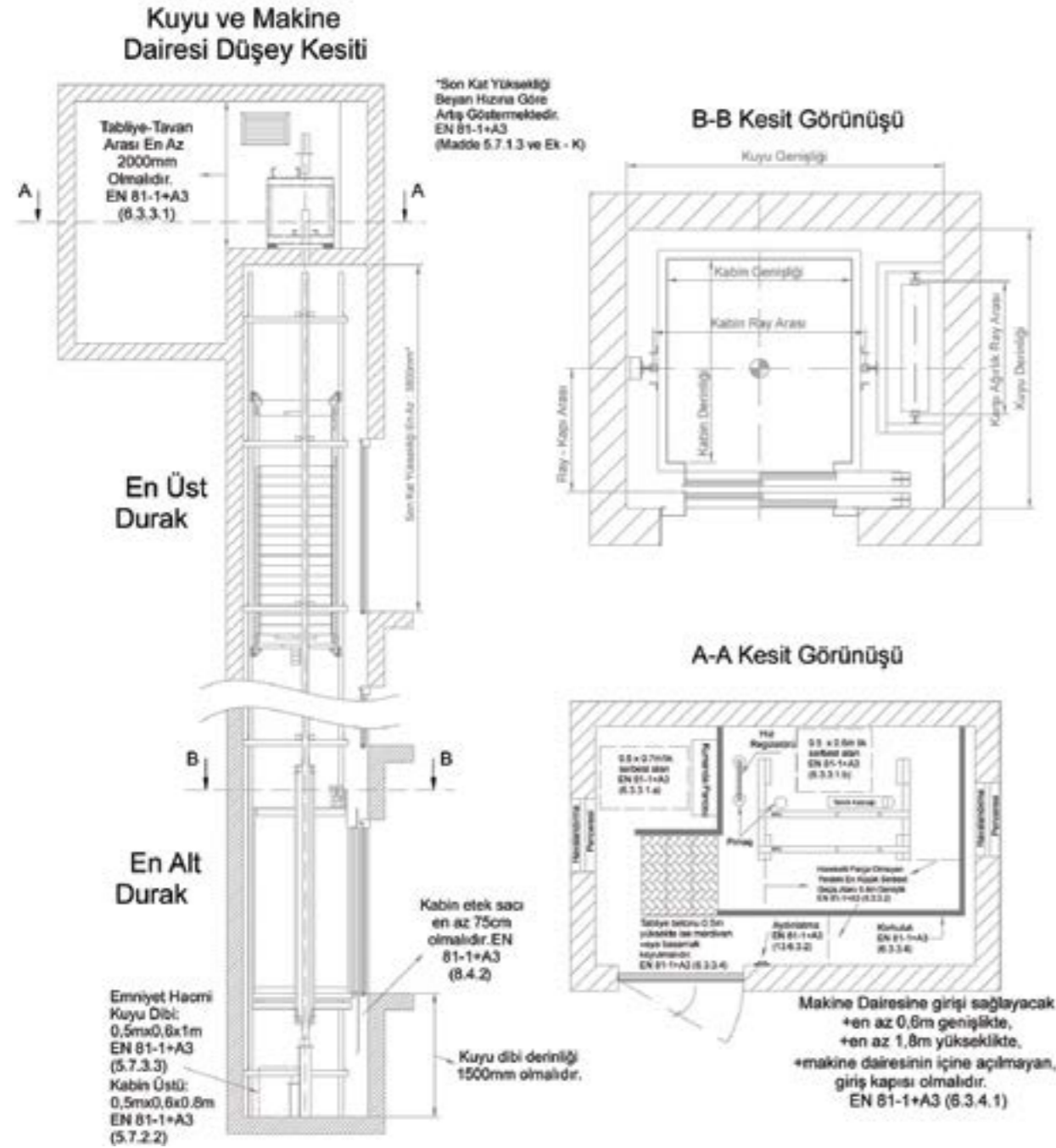

MAKİNE DAİRESİZ / MACHINE-ROOMLESS

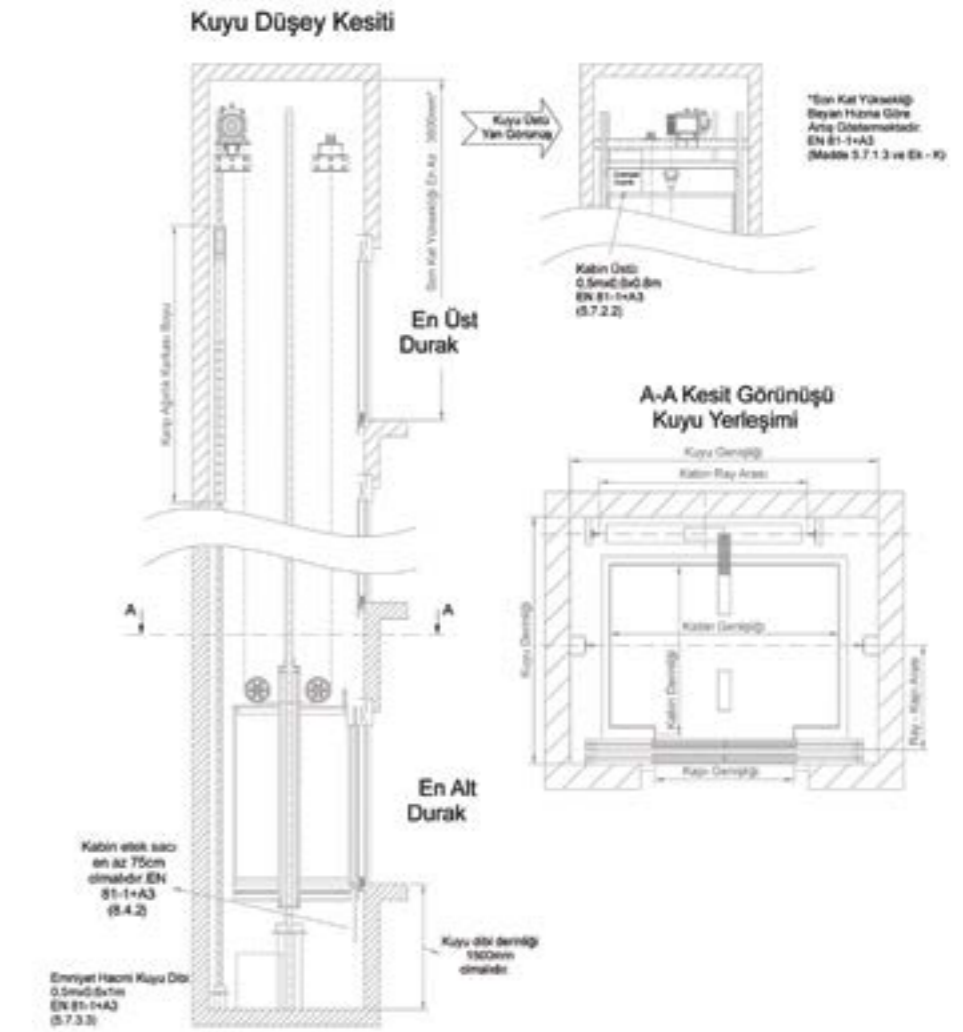
Makine dairesiz sistemlerin avantajları;
The advantages of the machine-roomless elevator systems;

- 1 Dişlisiz motorun ekonomik boyutları ile bina hacminde tasarruf sağlar.
 - 2 Son teknoloji kontrol teknikleri ile eşsiz konumlama hassasiyeti sağlar.
 - 3 Her çeşit binaya kolaylıkla monte edilir.
 - 4 Kaldırma ünitesinin üstün performansı, sessiz ve konforlu bir seyir sağlar.
 - 5 Daha az demeraj akımı çeker ve daha az enerji tüketir.
 - 6 Hızlı ve etkin montaj yapılmasına olanak verir.
 - 7 Optimum performans.
- 1 With gearless motor's economic size provides save on the volume of the building.
 - 2 With latest control techniques provides high sensitivity positioning.
 - 3 This system is easily mounted to all kinds of buildings.
 - 4 Lifting unit with superior performance provides quiet and comfortable movement.
 - 5 Consumes less energy and draws less starting current.
 - 6 Allows for fast and efficient installation.
 - 7 Optimum performance.





YÜRÜYEN MERDİVEN VE BANT SİSTEMLERİ
ESCALATOR AND MOVING WALKWAY SYSTEMS

ake



Konfor; her yerde, herkese...
Comfort; everywhere, for
everybody...



HAYATIN İÇİNDEN “KAYAN” ZAMANI

teknoloji, insan ve tecrübeyle yakalamanın keyfi; AKE.

**AKE; The joy of capturing
TIME “SLIPPING” THROUGH LIFE
with technology, humanity and experience.**

Teknolojik alışkanlıklarımız, büyüyen üretim alanlarımız, refleksimiz olan tecrübe ve kalite algımızla, konforlu insan transferi olanaklarının yaratıldığı tüm alanlarda lider bir marka yaratıyoruz. Geriye bakmadan, birlikte, her yöne, yanınızda AKE var.

We are creating a leading brand with our technological practices, our experience that is like a reflex for us, our perception of quality, and growing production in all areas where comfortable transfer facilities are created. Without looking back, together as one, you have AKE on your side in all directions.



AKE, AR-GE çalışmalarına durmaksızın devam ederek, teknolojisini gün geçtikçe ilerletiyor ve büyüyor.

AKE is developing his technology with continuing R&D activities, and growing day by day.

ESCALATOR

YÜRÜYEN MERDİVEN

MOVING WALKWAY

YÜRÜYEN BANT

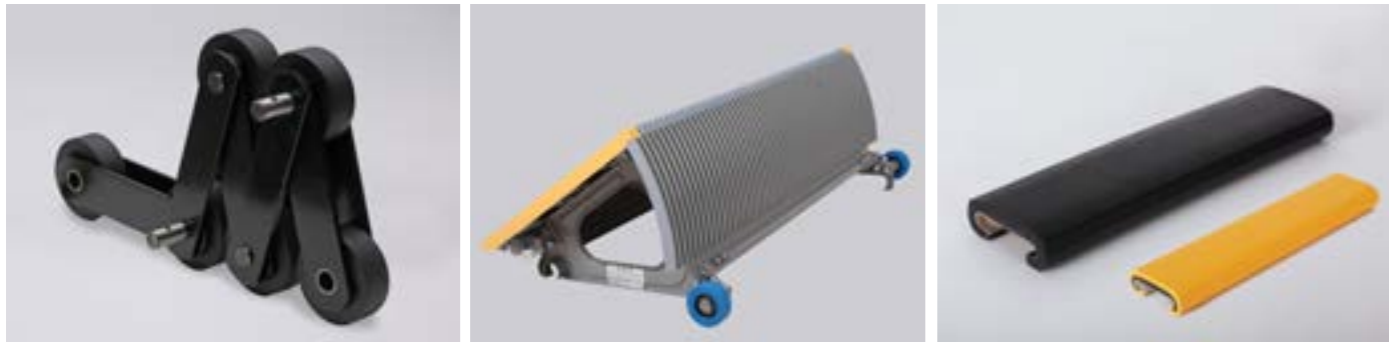
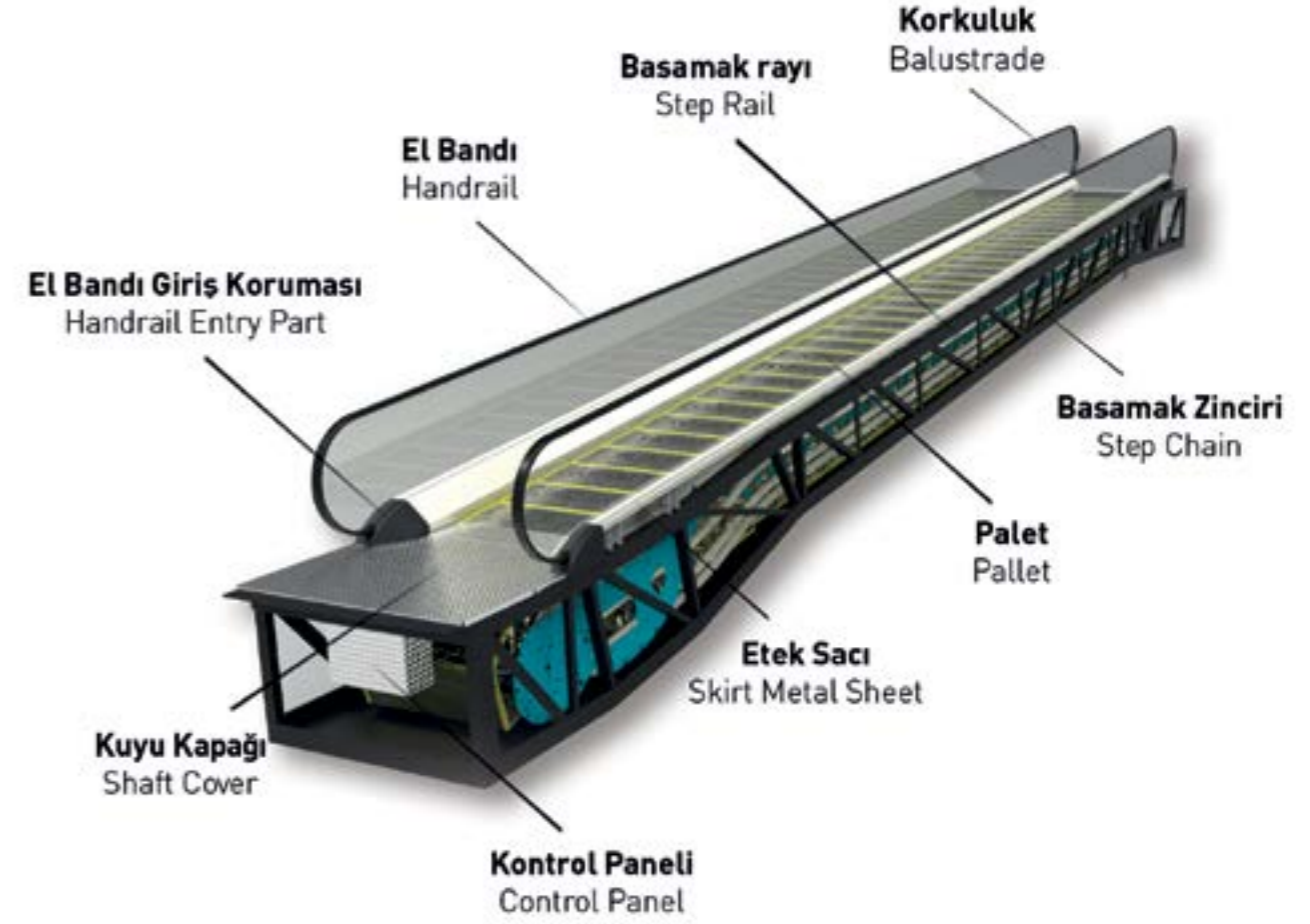
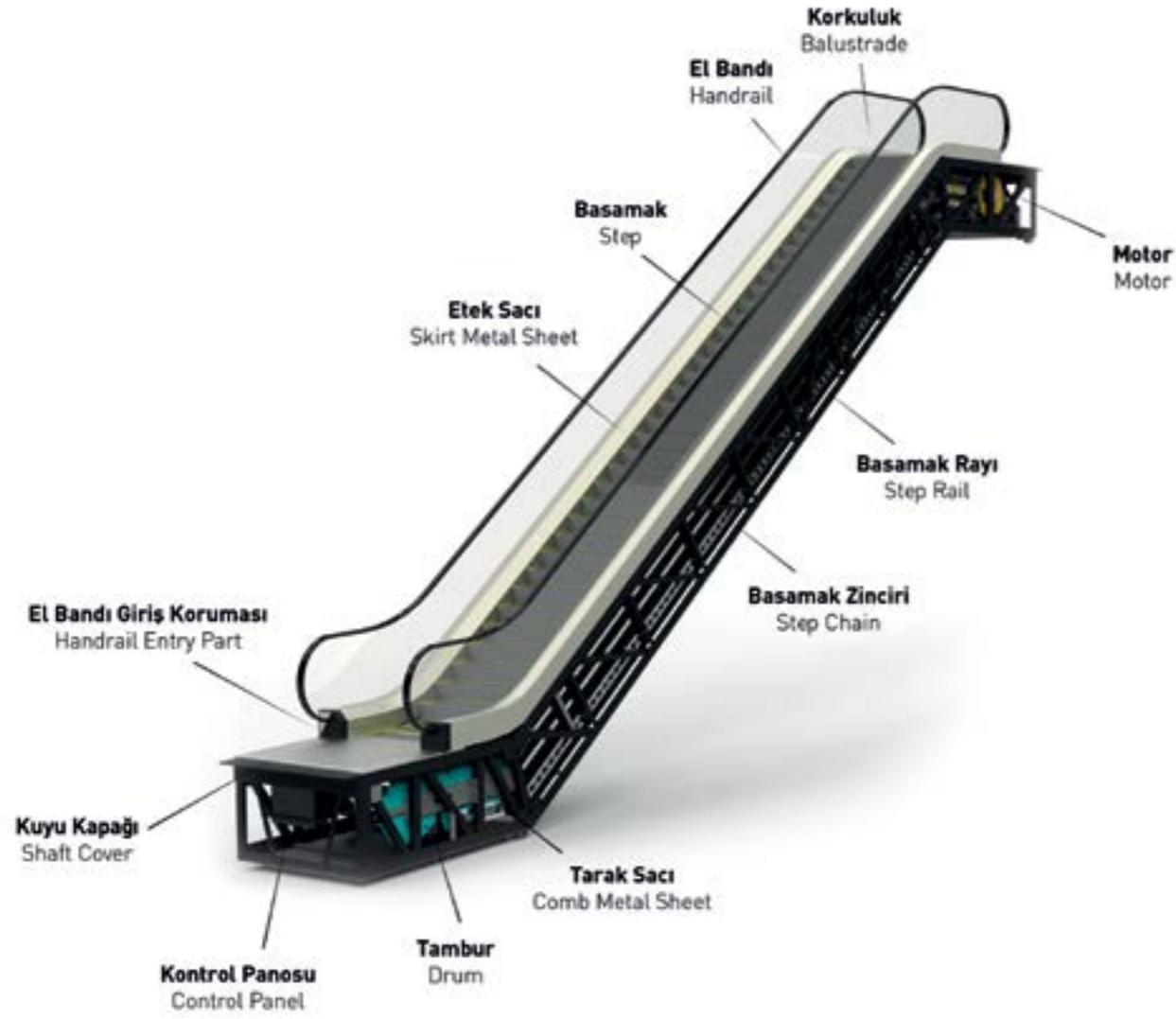

▶ AKE , HER TÜRLÜ YEDEK PARÇA DESTEĞİNİ SAĞLAMAKTADIR.



▶ AKE IS PROVIDING WITH ALL KIND OF SPARE PARTS.

ake

Asansör, Yürüyen Merdiven, Engelli Sistemleri
Elevator, Escalator, Disabled Systems





ENGELLİ SİSTEMLERİ
DISABLED SYSTEMS

ake



*Her koşulda herkese hareket özgürlüğü.
Freedom of movement for all under any condition.*



DÜNYA DÜZDÜR, BİR ADIM YETER

THE EARTH IS FLAT, ONE STEP IS ENOUGH

İşimiz bu... Gündelik yaşamda önünüze çıkan bütün engelleri yok etmek. Varacağımız yerle aramızdaki basamakları kaldırmak. Farklı seviyeleri hizaya getirmek, katları ve eğimleri bedensel formumuzu hiç değiştirmeden aşmak. İnsanın dimdik durması için imkansız bile inanmak, çünkü dünya düzdür. İstisnalar varsa düzeltiriz.

This is our job... To destroy all obstacles that come to your way. Remove the stairs between us and the point that we want to arrive. To align the different levels, negotiate the floors and inclinations without changing our physical form. Believe impossible to stand straight, because the earth is flat. If there are exceptions, we correct them.



AKE; her türlü merdiven tipine uygun çözümler üreterek, zamanı yakalamanızı sağlar.

Through creating suitable solutions for all kind of stair types, AKE gives chance to be free.

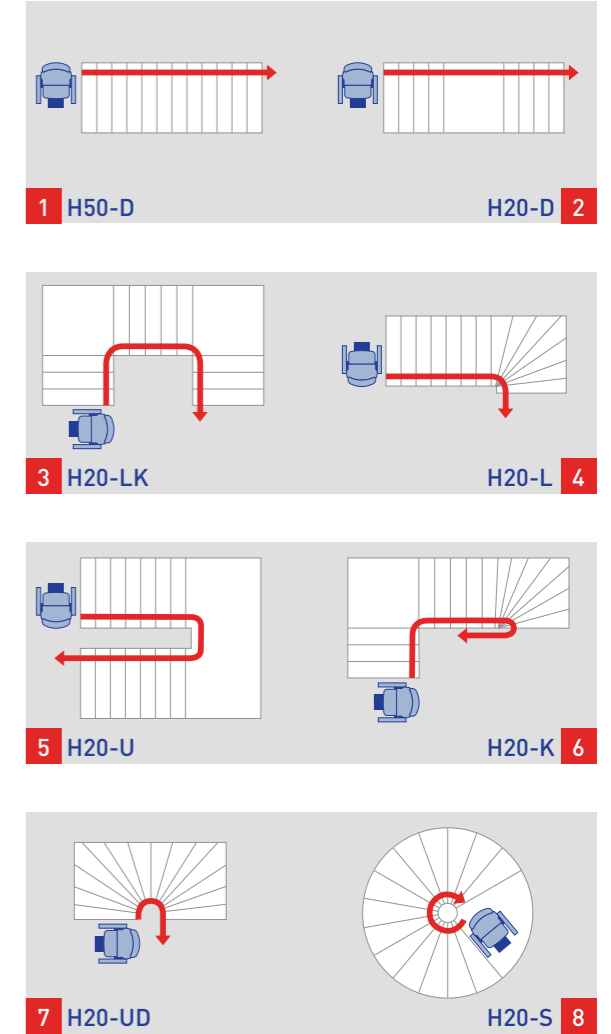

INCLINED WHEELCHAIR LIFT HIRO 320 MERDİVEN TİPİ ENGELLİ PLATFORMU HIRO 320

INCLINED WHEELCHAIR LIFT AKE-HIRO 350 MERDİVEN TİPİ ENGELLİ PLATFORMU AKE-HIRO 350

Referanslar / References



Referanslar / References



TEKNİK ÇİZİM / TECHNICAL DRAWING

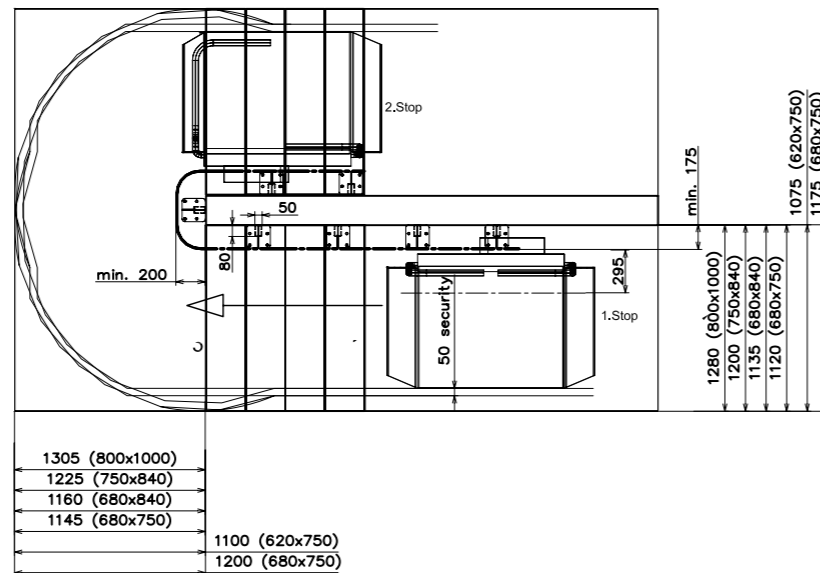

TEKNİK ÇİZİM / TECHNICAL DRAWING

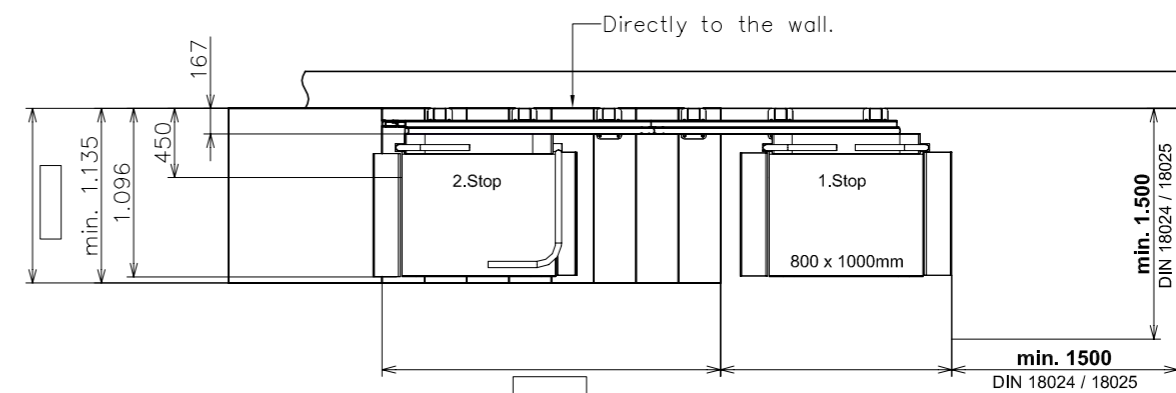

STAIRCASE CHAIR LIFT **HIRO 160**
KOLTUK TİPİ MERDİVEN ASANSÖRÜ
HIRO 160

POOL LIFT
KOLTUK TİPİ HAVUZ ASANSÖRÜ

Referanslar / References



Referanslar / References

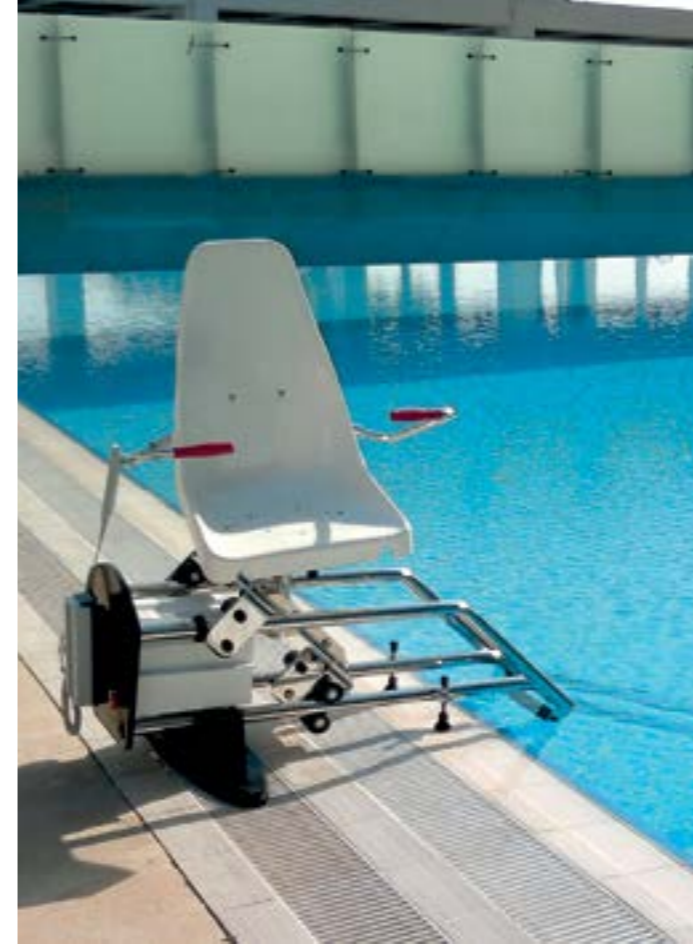
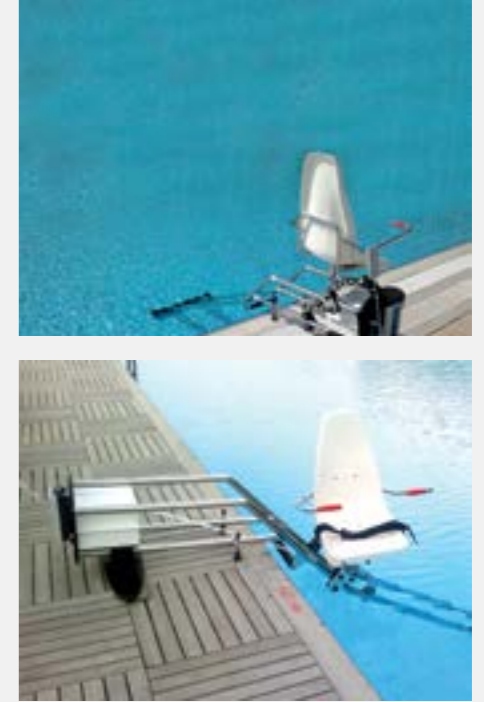

TEKNİK ÇİZİM / TECHNICAL DRAWING

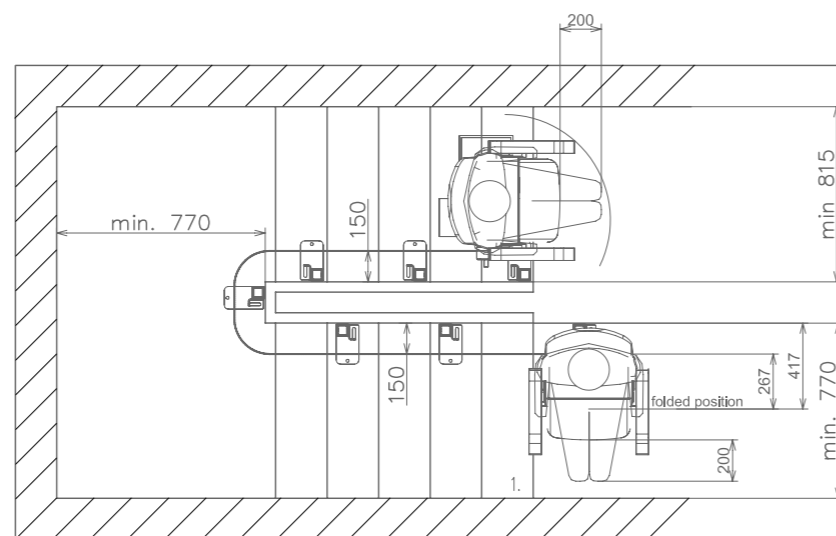
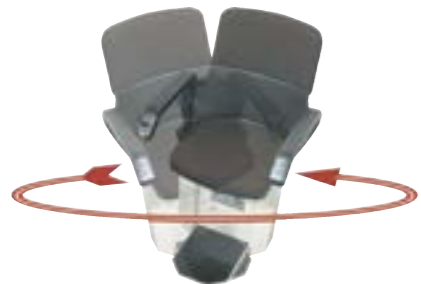

TEKNİK ÇİZİM / TECHNICAL DRAWING

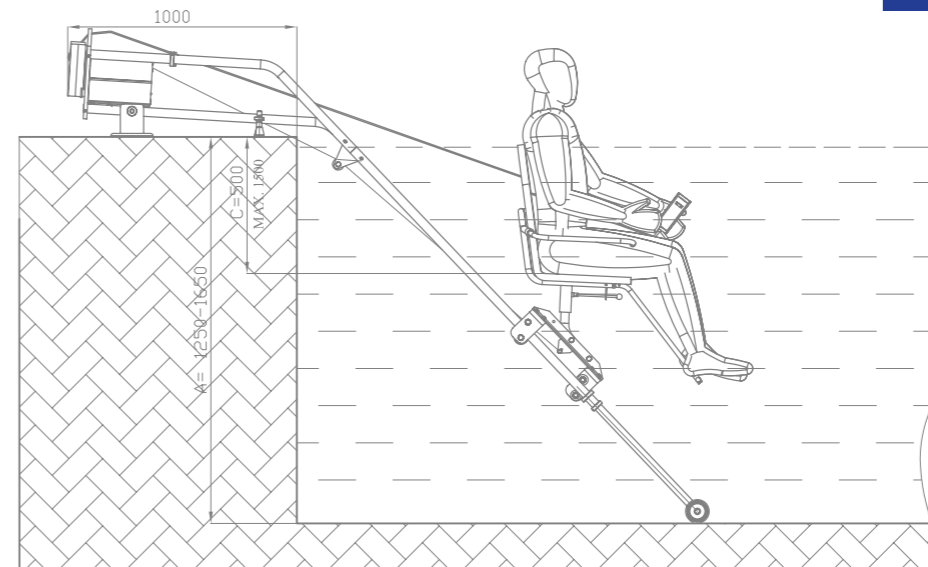



VERTICAL WHEELCHAIR LIFT **WORMLIFT WLP 300**
DIKEY TİP ENGELLİ PLATFORMU
WORMLIFT WLP 300

VERTICAL WHEELCHAIR LIFT **WORMLIFT WLP 400**
DIKEY TİP ENGELLİ PLATFORMU
WORMLIFT WLP 400

Referanslar / References



Referanslar / References



TEKNİK ÇİZİM / TECHNICAL DRAWING

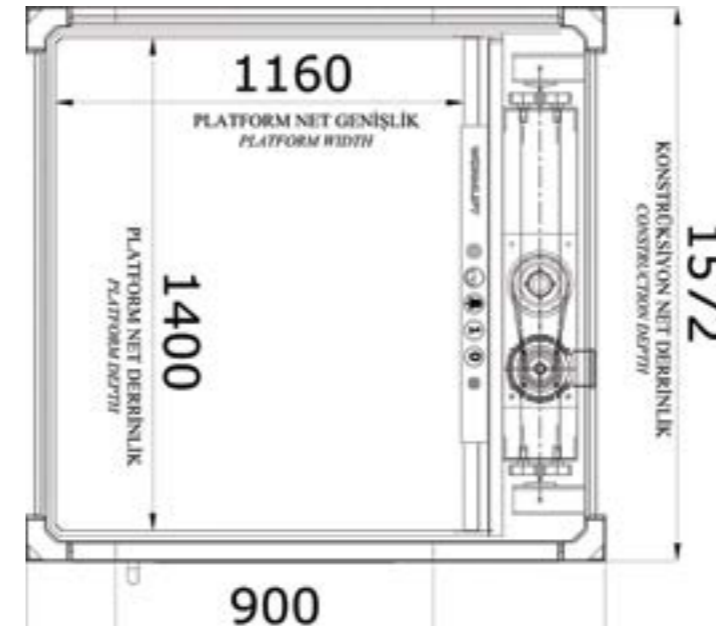
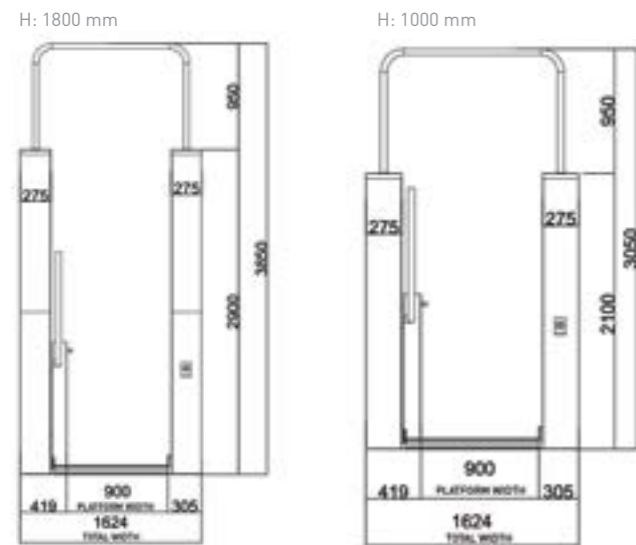

TEKNİK ÇİZİM / TECHNICAL DRAWING

ÖZEL ÇÖZÜMLER
SPECIAL SOLUTIONS

ake



Size özel...
Special for you...



BENİM ASANSÖRÜM, BENİM KONFORUM... MY ELEVATOR, MY COMFORT...

AKE 20 yıldır konforlu ve güvenli insan transferiyle kullanıcıların kalbine ulaşarak, yeniliklerin beklendiği marka olmanın gururunu paylaşmaya devam ediyor. Kuyu dibi ve son kat ölçüleri düşük, hatta olmayan mevcut ve yeni yapılara asansör çözümü olarak tasarlanmış bir sistemimizi AKE konforu ile sunuyoruz.

AKE continues to share the honour of being a brand from which innovations are expected by reaching the hearts of consumers with comfortable and reliable human transfer for 20 years.

We present our system with AKE comfort, which is designed as an elevator solution for new structures having low, even non-existent pit depth and head room dimensions.

AKEMYLIFT

Q-LINE

TEKNİK ÖZELLİKLER / TECHNICAL INFORMATION

- Makine dairesiz sisteme sahip olup dişlisiz motor ile çalışır.
- Kuyu dibi min. 250 mm, son kat ölçüsü ise min. 2700 mm'dir.
- Maks. 1.00 m/s hızla hareket etmektedir.
- 320 kg, 450 kg ve 630 kg olarak farklı taşıma kapasitelerine sahiptir.
- Maks. seyir mesafesi 5 durak / 15 m'dir.
- TS EN 81-1 + A3:2011, TS EN 81-21:2011 standartlarına ve 95/16/AT Asansör direktiflerine uygundur.
- Farklı yönlerden giriş seçenekleri mevcuttur.
- Özel tasarım modüler çelik ile montajı kolay olan civatalı konstrüksiyondur.

- It has a machine roomless system and works with gearless motor.
- Pit is min. 250 mm, head room measure is 2700 mm.
- Acts with maximum 1.00 m/s speed.
- There are three different capacities as 320 kg, 450 kg and 630 kg.
- Max. travel distance is 5 stops /15 m.
- It's in accordance TS EN 81-1 + A3:2011, TS EN 81-21:2011 standarts and 95/16/AT lift directives.
- Entrance from different directions is available.
- It is an easy installation bolted connection construction with special design modular steel.



TEKNİK ÖZELLİKLER / TECHNICAL INFORMATION

- Makine dairesiz sisteme sahip olup dişlisiz motor ile çalışır.
- Kuyu dibi min. 300 mm, son kat ölçüsü ise 3000 mm'dir.
- Maks. 1.6 m/s hızla hareket etmektedir.
- Taşıma kapasitesi 240 kg ile 1000 kg arasında değişmektedir.
- Maks. seyir mesafesi 60 m'dir.
- TS EN 81-1 + A3:2011, TS EN 81-21:2011 standartlarına ve 95/16/AT Asansör direktiflerine uygundur.
- Asansör kuyu duvarlarına ihtiyaç duyulmamaktadır.
- Sahip olduğu özel kayışlı sistem ile çelik halata göre daha uzun ömürlüdür.

- It has a machine roomless system and works with gearless motor.
- Pit is min. 300 mm, head room measure is 3000 mm.
- Acts with maximum 1.6 m/s speed.
- The capacity differs between 240 kg and 1000 kg.
- Max. travel distance is 60 m.
- It's in accordance TS EN 81-1 + A3:2011, TS EN 81-21:2011 standarts and 95/16/AT lift directives.
- There is no need for shaft walls.
- Comparing to steel rope system, it is more durable with its special belt system.



DETAYLAR / DETAILS



DETAYLAR / DETAILS



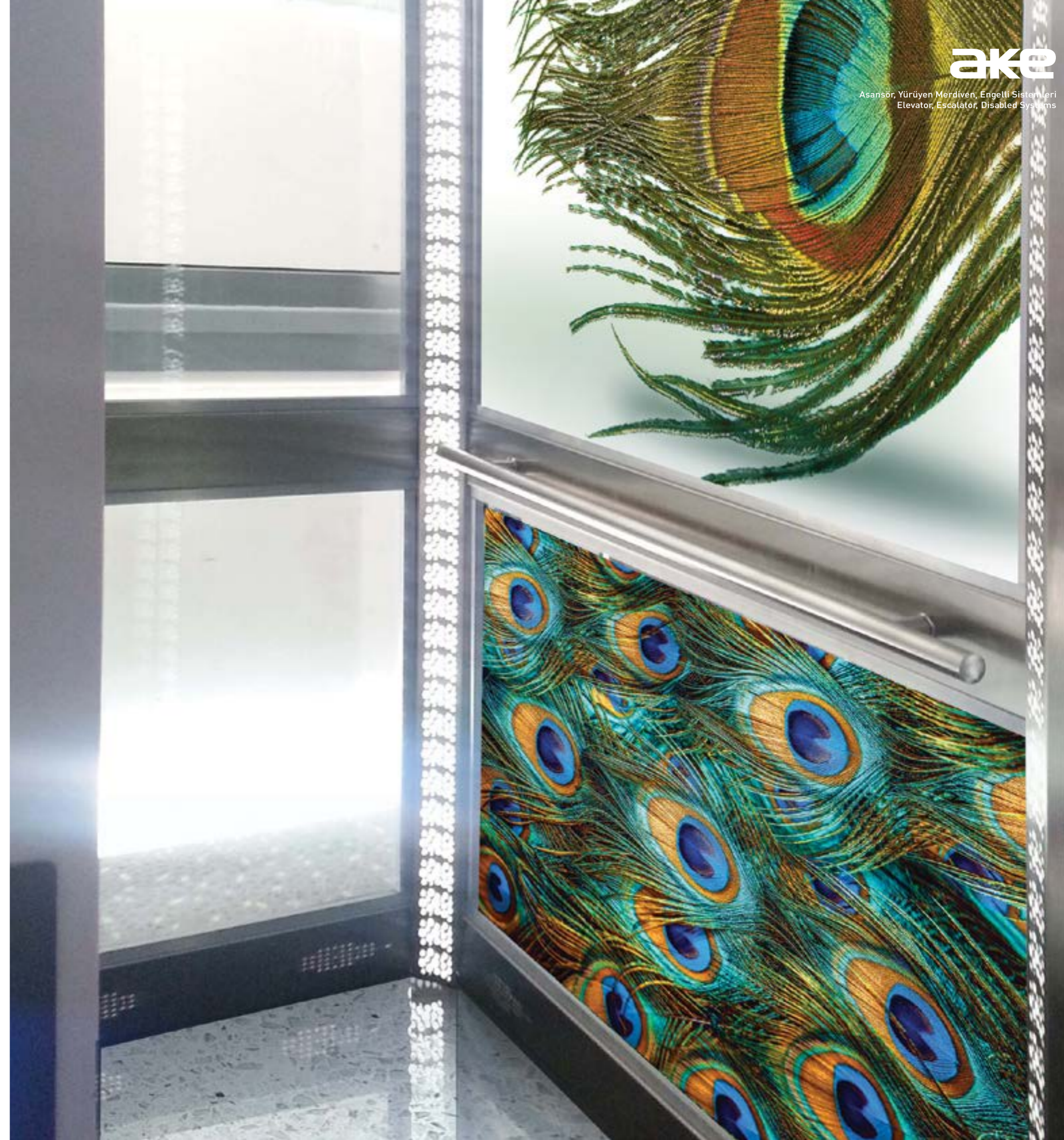
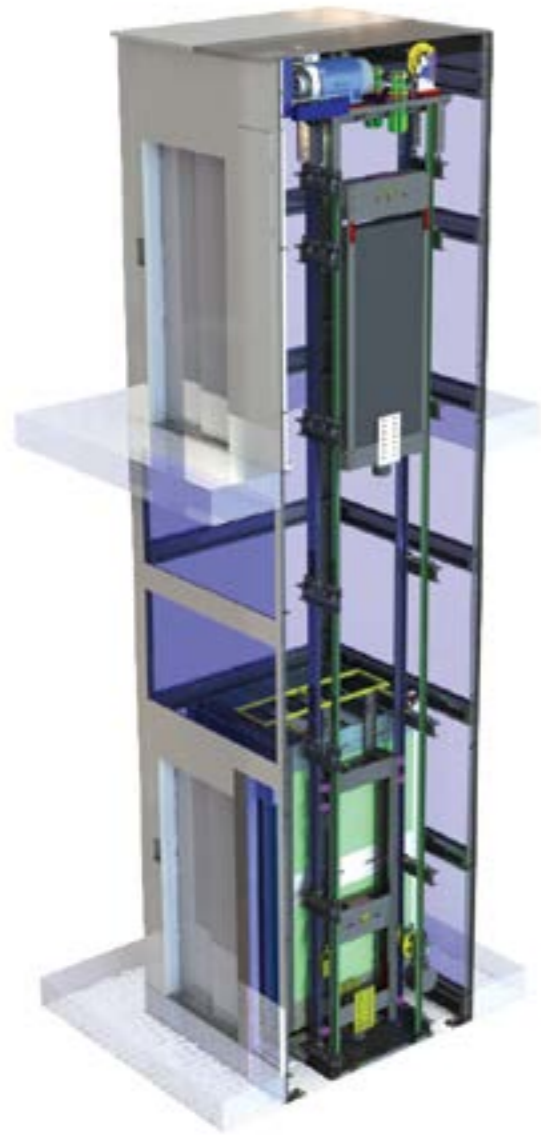

ake

Asansör, Yürüyen Merdiven, Engelli Sistemleri
Elevator, Escalator, Disabled Systems

TECHNICAL SERVICE

TEKNİK SERVİS



AKE ASSISTANCE ile kaliteli ve ekonomik teknik servis hizmeti ile müşteri memnuniyetini en üst düzeyde sağlamaktayız. İletişimi güçlü uzman teknik kadromuz ile asansör, yürüyen merdiven ve engelli sistemleri servisinde güven veriyoruz.

With **AKE ASSISTANCE**, we are providing customer satisfaction at highest level with qualitative and economic technical service. Through strong communication skills, we assure with our specialized technical team in elevator, escalator and disabled systems.



AVANTAJLARIMIZ; ADVANTAGES;

Farklı marka asansör ve yürüyen merdiven servisinde uzmanlık	Specialized in different brands of elevator and escalator services
Güvenilir ve ekonomik maliyetli hizmetler	Trustful and low cost services
7/24 Servis	7/24 service
Orijinal yedek parça stoğu	Original spare parts stock
Bayilere teknik bilgi destek hizmeti	Technical information support for distributors
Sürekli eğitim	Continuing education



AKE GÜVENCESİ ile AKE GUARANTEES

Performans artışı, enerji tasarrufu, güvenlik ve standartlara uygunluk ve yapıya uygun ergonomik çözümler.

High performance, energy saving, conforming to standards, economic and integrating solutions with buildings.



Asansör, Yürüyen Merdiven, Engelli Sistemleri
Elevator, Escalator, Disabled Systems