



www.yukselisasansor.com.tr

YÜKSELİŞ ASANSÖR

Hedefiniz Yükselmek İse Yükselmenin Yolu **YÜKSELİŞ** 'tir.



İçindekiler / Contents

				
03 Hakkımızda			04-05 Ofis Genel Görünüm	
			07-45 Kabinler	
46 Tavan Modelleri			48 Laminantlar	
			50 Fabrikadan Görünüm	
	52-53 Kabin İskeletleri			54-55 Kabin Kapıları
	56-57 Kabin Mekanizmaları			60 Butonlar
			61 TFT Göstergeler	
	64 Sertifikalarımız			





YÜKSELİŞ ASANSÖR SANAYİ VE TİCARET LİMİTED ŞİRKETİ

Sektöre uzun yıllar hizmet vermiş olan Yükseliş Asansör, kararlı ve prensipli yönetim anlayışı ile, kaliteli üretim için hizmet yarışındaki konumunu sürekli muhafaza etmektedir. YÜKSELİŞ ASANSÖR, kendi arazisi üzerine yapmış olduğu yeni fabrika binası ile alanını daha da genişleterek, müşteriye memnun edebilmek için, şirket organizasyonu ve verilen hizmetin niteliği YÜKSELİŞ için ön planda olmuş, yatırımlarını devamlı olarak bu yönde yapmış ve yapmaya da devam etmektedir, bunun neticesinde mevcut kapasitemizi iki katına çıkartarak üretim hattımızı genişletiyoruz. Araştırma, üretim ve pazarlama departmanları arasındaki iletişim ve devamlı görüş alışverişi, YÜKSELİŞ'İN en büyük gücünü oluşturmuştur, bu iletişim sayesinde ise, müşteriye her zaman eksiksiz ve en iyi hizmeti verebilmektedir. Çağdaş teknoloji, yıllardır izlenen etkili yatırım programları ve uzmanlaşmış kadro YÜKSELİŞ birimlerinin ortak noktası olmuştur...

YÜKSELİŞ ASANSÖR, imal ettiği ürünleri, uluslararası standartlara uygun bir şekilde yurtiçi ve yurtdışına pazarlamaktadır. Bu doğrultuda hedefiniz yükselmek ise, yükselmenin yolu YÜKSELİŞ'tir...

YÜKSELİŞ ELEVATOR, has been serving the elevator sector for long years with the determined and high principle management for quality of its production to keep its stand constantly on the service and competition.

YÜKSELİŞ has developed its field more with newly constructed factory on its own area for satisfaction of the clients, company organization and presented service quality; has been in the most important aim for YÜKSELİŞ and it has been investing on that direction and will continue in the future. As a result of this we enlarge our production line by doubling the current capacity. Communication and exchange of views between the Research-Development, production and marketing departments are constitution of YÜKSELİŞ's utmost power. Through this communication we always serve perfect and the best for our clients. The modern technology, investment programs which have been observed for years and specialized permanent staff are included in YÜKSELİŞ common point.

YÜKSELİŞ ELEVATOR is marketing its manufactured products in domestic market and worldwide with international standarts appropriately.

If your aim is to rise, the way to rise is with YÜKSELİŞ...



OFİS GENEL GÖRÜNÜM



OFFICE GENERAL VIEW



If Your Target Is To Rise, The Road To Rise Is With YÜKSELİŞ...

Döner Asansör / Rotating Lift



DÜNYADA
İLK VE TEK...

KAPI - KABİNLER / DOOR - CABINS

Birbirinden şık ve kullanışlı kendi imalatımız olan modern kabinler..

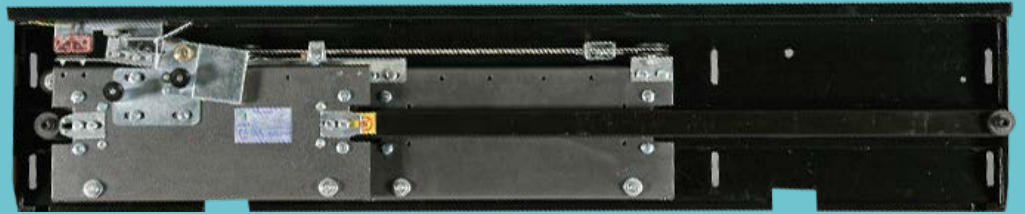

CALICO

Kabin Kaplama Özellikleri

- Tavan** : Ahşap İşlemeli Altın Varak
- Paneller** : Ceviz Kaplama
- Profiller** : Ahşap Sarı Varak
- Tutamak** : Arkada Tekli Sarı Piriç Boru
- Ayna** : 3 Tarafta Oval Beyaz Flotal
- Aydınlatma** : Kristal Taşlarla Döşenmiş Ledli Aydınlatma
- Süpürgelik** : Ahşap Sarı Varak
- Zemin** : Granit+(Giallo. Fiorito)
- İlaveler** : Aşın Yük, Fan



CALICO

Car Interior Materials

- Ceiling** : Wood Embroidered Cabin
- Wall Panels** : Walnut Layover
- Profiles** : Wooden Golden Leaf
- Handrail** : Single Yellow Brass Pipe On The Back Wall
- Mirror** : Oval White and floating mirror on Three Walls
- Lightning** : Let Lighting Furnished With Flint Stones
- Kickplate** : Wooden Golden Leaf
- Floor** : Granite (Giallo, Fiorito)
- Options** : Overload, Fan



TORPEDO

Kabin Kaplama Özellikleri

- Tavan** : Satine Paslanmaz Çelik
- Paneller** : Granit + Satine Paslanmaz + Ayna
- Profiller** : Satine Paslanmaz
- Tutamak** : Her Üç Tarafa Paslanmaz Boru
- Ayna** : Her Üç Tarafa Üçer Sıra
- Aydınlatma:** Flouresan
- Süpürgelik** : Satine Paslanmaz Çelik
- Zemin** : Siyah Granit
- İlaveler** : Ayna Araları 15mm.
Satine Paslanmaz Profil



TORPEDO



Car Interior Materials

- Ceiling** : Satinated stainless Steel
- Wall Panels:** Granite + Satinated Stainless + Mirror
- Profiles** : Satinated Stainless
- Handrail** : Single Stainless Pipe On Each Three Sides
- Mirror** : Three Lines Mirror All Of The Walls
- Lightning** : Fluorescent
- Kickplate** : Satinated Stainless Steel
- Floor** : Black Granite
- Options** : 15mm. Between The Mirrors
Satinated Stainless Profile



EŞKİNA

Kabin Kaplama Özellikleri

- Tavan** : Satine+ Sarı Ayna P. Çelik, Lazer Kesim
- Paneller** : Satine Paslanmaz Çelik
- Profiller** : Sarı Ayna P.Çelik, Kabartmalı
- Tutamak** : Arkada Tekli Özel Tutamak
- Ayna** : Arkada Yarım En, Tam Boy
- Aydınlatma:** Floresan+Spot
- Süpürgelik** : Satine Paslanmaz Çelik
- Zemin** : Granit+Sarı Ayna P.Çelik
- İlaveler** : Aşırı Yük, Fan



EŞKİNA

Car Interior Materials

- Ceiling** : Satinated+Yellow Mirror S. Steel,
Laser Cutting
- Wall Panels:** Satinated S. Steel
- Profiles** : Yellow Mirror S. Steel, Embossed
- Handrail** : Single special Hand Rail On The Back
- Mirror** : Half Width, Full Length On The Back
- Lightning** : Fluorescent+ Spot
- Kickplate** : Satinated S. Steel
- Floor** : Granite+ Yellow Mirror S.Steel
- Options** : Overload, Fan



MORİNA

Kabin Kaplama Özellikleri

- Tavan** : Satine Paslanmaz Çelik
- Paneller** : Satine Paslanmaz+Laminat Kaplama
- Profiller** : Satine Paslanmaz
- Tutamak** : Arkada İkili Paslanmaz Boru
- Ayna** : Arka Tutamak Üstü Tam En
- Aydınlatma:** Floresan
- Süpürgelik** : Satine Paslanmaz Çelik
- Zemin** : Granit
- İlaveler** : Laminant Aralarında 5 mm
Satine Paslanmaz Boşluk



MORİNA



Car Interior Materials

- Ceiling** : Satinated stainless Steel
- Wall Panels:** Satinated Stainless+ Laminate Covered
- Profiles** : Satinated Stainless
- Handrail** : Double Stainless Pipe On The Back
- Mirror** : Full With Of The Back Handrail Top
- Lightning** : Fluorescent
- Kickplate** : Satinated Stainless Steel
- Floor** : Granite
- Options** : 5 mm. Satinated stainless cavity between the laminates



LAGOS

Kabin Kaplama Özellikleri

- Tavan** : Satine Paslanmaz Çelik
- Paneller** : Satine Paslanmaz Bombe Kabartma Desenli
- Profiller** : Ayna Paslanmaz
- Tutamak** : İkili Paslanmaz
- Ayna** : Tam boy Arka Duvarda
- Aydınlatma**: Floresan
- Süpürgelik** : Satine paslanmaz
- Zemin** : Antibakteriyal PVC
- İlaveler** : Özel Formlu Tavan Armatürü



LAGOS



Car Interior Materials

- Ceiling** : Satinated Stainless Steel
- Wall Panels:** Satinated Stainless Embossed Designed
- Profiles** : Mirror Stainless
- Handrail** : Double Stainless
- Mirror** : Full Length On The Back Wall
- Lightning** : Fluorescent
- Kickplate** : Satinated Stainless
- Floor** : Antibacterial Pvc
- Options** : Special Form Ceiling Armature



ÇİPURA

Kabin Kaplama Özellikleri

- Tavan** : Nokta P.Çelik,Lazer Kesim
- Paneller** : Laminat
- Profiller** : Nokta P.Çelik+ Ayna P.Çelik
- Tutamak** : Arkada İkili P. Çelik Boru
- Ayna** : Arkada Yarım En, Tam Boy
- Aydınlatma:** Fluoresan+ Spot
- Süpürgelik** : Nokta P.Çelik
- Zemin** : Pvc
- İlaveler** : Aşırı Yük, Fan, Üçgen Köşe,
Ayna Ken. Aydınlatma



ÇİPURA

Car Interior Materials

Ceiling : Point S. Steel, Laser Cutting

Wall Panels: Laminate

Profiles : Point S. Steel + Mirror S. Steel

Handrail : Double S. Steel Pipe On The Back

Mirror : Half Width, Full Length On The Back

Lightning : Fluorescent+ Spot

Kickplate : Point S. Steel

Floor : Pvc

Options : Overload, Fan, Triangle Corner, Lighting İn Mirror Side



ÇİTARİ

Kabin Kaplama Özellikleri

- Tavan** : Nokta P.Çelik, Lazer Kesim
- Paneller** : Laminat
- Profiller** : Nokta + Ayna P. Çelik
- Tutamak** : Arkada İkili Özel Tutamak
- Ayna** : Arkada İki Parça, Tam En, Tam Boy
- Aydınlatma:** Flouresan
- Süpürgelik** : Nokta P.Çelik
- Zemin** : Pvc
- İlaveler** : Aşırı Yük, Fan, Üçgen Köşe



ÇİTARİ



Car Interior Materials

- Ceiling** : Point S. Steel, Laser Cutting
- Wall Panels:** Laminate
- Profiles** : Point + Mirror S. Steel
- Handrail** : Double Special Hand Rail On The Back
- Mirror** : 2 Parts Full Width, Full Length On The Back
- Lightning** : Fluorescent
- Kickplate** : Point S. Steel
- Floor** : Pvc
- Options** : Overload, Fan, Triangle Corner



AFANYUS

Kabin Kaplama Özellikleri

- Tavan** : Decoplate
- Paneller** : Decoplate Gri ve Siyah
- Profiller** : Decoplate
- Tutamak** : Arkada İkili Paslanmaz Boru
- Ayna** : Arkada Yarım En Tam Boy
- Aydınlatma:** Floresan + Spot
- Süpürgelik** : Decoplate Gri
- Zemin** : Bluepearl Granit
- İlaveler** : Yatay Döşeme



AFANYUS



Car Interior Materials

Ceiling : Decoplate

Wall Panels: Decoplate Grey and Black

Profiles : Decoplate

Handrail : Double Stainless Pipe On The Back

Mirror : Half Width, Full Length + Spot

Lightning : Fluorescent + Spot

Kickplate : Decoplate Grey

Floor : Bluepearl Granite

Options : Horizontal Flooring



TRAKONYA

Kabin Kaplama Özellikleri

- Tavan** : Satine Paslanmaz Çelik
- Paneller** : Satine Paslanmaz
- Profiller** : Çapraz Kare Desen Paslanmaz
- Tutamak** : Arkada İkili Boru
- Ayna** : Arka Baklava Model
- Aydınlatma**: Flouresan
- Süpürgelik** : Satine Paslanmaz Çelik
- Zemin** : Granit
- İlaveler** : Yan Duvarlar Kare Kabartma Desenli



TRAKONYA

Car Interior Materials

Ceiling : Satinated stainless Steel

Wall Panels: Satinated Stainlees

Profiles : Crosswise, Square Figured Stainless

Handrail : Double Pipe On The Back

Mirror : Diamond – Shaped Model On The Back

Lightning : Fluorescent

Kickplate : Satinated Stainless Steel

Floor : Granite

Options : Side Walls Square Embossed Designed



AYMOLİ

Kabin Kaplama Özellikleri

Tavan	:	Decoplate
Paneller	:	Decoplate
Profiller	:	Dcoplate
Tutamak	:	Yok
Ayna	:	Yanlarda Boy Ayna
Aydınlatma:		Spot + Floresan
Süpürgelik	:	Yok
Zemin	:	Siyah Granit
İlaveler	:	Kabin Duvarları Dışbükey Formda



AYMOLİ



Car Interior Materials

Ceiling : Decoplate

Wall Panels: Decoplate

Profiles : Decoplate

Handrail : No

Mirror : Length Mirror On The Sides

Lightning : Spot + Fluorescent

Kickplate : No

Floor : Black Granite

Options : Cabin Walls On The Convex Form



FRONTOZA

Kabin Kaplama Özellikleri

- Tavan** : Nokta P. Çelik + Decosteel, Lazer Kesim
- Paneller** : Laminat + Decosteel
- Profiller** : Nokta P. Çelik
- Tutamak** : Yan Duvarlarda P. Çelik Boru
- Ayna** : Arkada Yarım Boy
- Aydınlatma:** Floresan + Spot
- Süpürgelik** : Nokta P. Çelik
- Zemin** : Granit
- İlaveler** : Aşırı Yük, Fan, Köşede Aydınlatma



FRONTOZA

Car Interior Materials

Ceiling : Point S. Steel + Decosteel, Laser Cutting

Wall Panels: Laminate + Decosteel

Profiles : Point S. Steel

Handrail : S. Steel Pipe On The Side Walls

Mirror : Half Length On The Back

Lightning : Fluorescent + Spot

Kickplate : Satinated Stainless Steel

Floor : Granite

Options : Overload, Fan, Lighting In Corner



TRANÇA

Kabin Kaplama Özellikleri

- Tavan** : Nokta P. Çelik, Lazer Kesim
- Paneller** : Nokta P. Çelik + Laminat
- Profiller** : Ayna P. Çelik + Nokta P. Çelik
- Tutamak** : Arkada Üçlü P. Çelik Boru
- Ayna** : Arkada Yarım En, Tam Boy
- Aydınlatma:** Flouresan
- Süpürgelik** : Nokta P. Çelik
- Zemin** : Granit
- İlaveler** : Aşırı Yük, Fan, Köşede Aydınlatma



TRANÇA



Car Interior Materials

- Ceiling** : Point S. Steel, Laser Cutting
- Wall Panels:** Point S. Steel + Laminate
- Profiles** : Mirror S. Steel + Point S. Steel
- Handrail** : Triple S. Steel Pipe On The Back
- Mirror** : Half width, Full length On The Back
- Lightning** : Fluorescent
- Kickplate** : Satinated Stainless Steel
- Floor** : Black Granite
- Options** : 15mm. Between The Mirrors
Satinated Stainless Profile



EKO

Kabin Kaplama Özellikleri

- Tavan** : Decoplate Gri
- Paneller** : Decoplate Gri ve Siyah
- Tutamak** : Arkada Tekli Paslanmaz Boru
- Ayna** : Arkada Yarım En, Tam Boy
- Aydınlatma:** Floresan
- Süpürgelik** : Decoplate Siyah
- Zemin** : PVC
- İlaveler** : Fan



EKO



Car Interior Materials

Ceiling : Decoplate Grey

Wall Panels: Decoplate Grey and Black

Handrail : Stainless Steel Pipe

Mirror : Half Width, Full Length On The Back

Lightning : Fluorescent

Kickplate : Decoplate Black

Floor : PVC

Options : Fan



TETRAZON

Kabin Kaplama Özellikleri

- Tavan** : Satine P. Çelik + Laminat, Laser Kesim
- Paneller** : Stine P.Çelik, Kabartmalı + Laminat
- Profiller** : Satine P. Çelik
- Tutamak** : Arkada İkili P. Çelik Boru
- Ayna** : Arkada Yarım En, Tam Boy
- Aydınlatma:** Floresan + Spot
- Süpürgelik** : Satine P. Çelik
- Zemin** : Pvc
- İlaveler** : Aşırı Yük, Fan, Köşede Aydınlatma



TETRAZON



Car Interior Materials

- Ceiling** : Satinated S. Steel + Laminate, Laser Cutting
- Wall Panels:** Satinated S. Steel, Embossed + Laminate
- Profiles** : Satinated S. Steel
- Handrail** : Double S. Steel Pipe On The Back
- Mirror** : Half width, Full Length On The Back
- Lightning** : Fluorescent + Spot
- Kickplate** : Satinated S. Steel
- Floor** : Pvc
- Options** : Overload, Fan, Lighting On The Corner



KARMOZ

Kabin Kaplama Özellikleri

- Tavan** : Satine P. Çelik, Laser Kesim
- Paneller** : Decosteel
- Profiller** : Ayna P. Çelik
- Tutamak** : Her Üç Tarafa Paslanmaz Boru
- Cam** : 5+5 mm Lamine Cam
- Aydınlatma:** Flouresan
- Süpürgelik** : Satine P. Çelik
- Zemin** : Granit
- İlaveler** : Aşırı Yük, Fan, Sarı Ayna
P. Çelik Kubbe



KARMOZ



Car Interior Materials

Ceiling : Satinated S. Steel, Laser Cutting

Wall Panels: Decosteel

Profiles : Mirror S. Steel

Handrail : S. Steel Pipe All Of The Walls

Glass : 5+5 mm Laminated Glass

Lightning : Fluorescent

Kickplate : Satinated S. Steel

Floor : Granite

Options : Overload, Fan, Yellow Mirror S. Steel Dome



ZARGANA

Kabin Kaplama Özellikleri

- Tavan** : Satine Paslanmaz Çelik
- Paneller** : Satine P. Çelik + Granit
- Profiller** : Satine P. Çelik
- Tutamak** : Tüm Duvarlarda P. Çelik Boru
- Cam** : 5+5 mm Lamine Cam
- Aydınlatma:** Spot
- Süpürgelik** : Satine P. Çelik
- Zemin** : Granit
- İlaveler** : Aşırı Yük, Fan, Satine P. Çelik Kubbe



ZARGANA



Car Interior Materials

Ceiling	:	Satinated S. Steel
Wall Panels:		Satinated S. Steel + Granite
Profiles	:	Satinated S. Steel
Handrail	:	S. Steel Pipe All Of The Walls
Glass	:	5+5 mm Laminated Glass
Lightning	:	Spot
Kickplate	:	Satinated S. Steel
Floor	:	Granite
Options	:	Overload, Fan, Satinated S. Steel Dome







If Your Target Is To Rise, The Road To Rise Is With **YÜKSELİŞ...**



BALİNA

Kabin Kaplama Özellikleri

- Tavan** : Açık
- Paneller** : Satine P. Çelik + 120 cm'den
Yukarı Tel Kafes
- Süpürgelik** : Satine P. Çelik
- Zemin** : Baklavalı Sac
- İlaveler** : Yanlarda Kılavuz Borusu



BALİNA

Car Interior Materials

Ceiling : Open

Wall Panels: Satinated S. Steel + Wire Lattice
Above From 120cm

Kickplate : Satinated S. Steel

Floor : Chequered Plate

Options : Guide Pipe On Sides



FABRİKA KABİN SHOWROOM



FACTORY CAR SHOWROOM



If Your Target Is To Rise, The Road To Rise Is With **YÜKSELİŞ...**

TAVAN MODELLERİ CEILING FIGURES

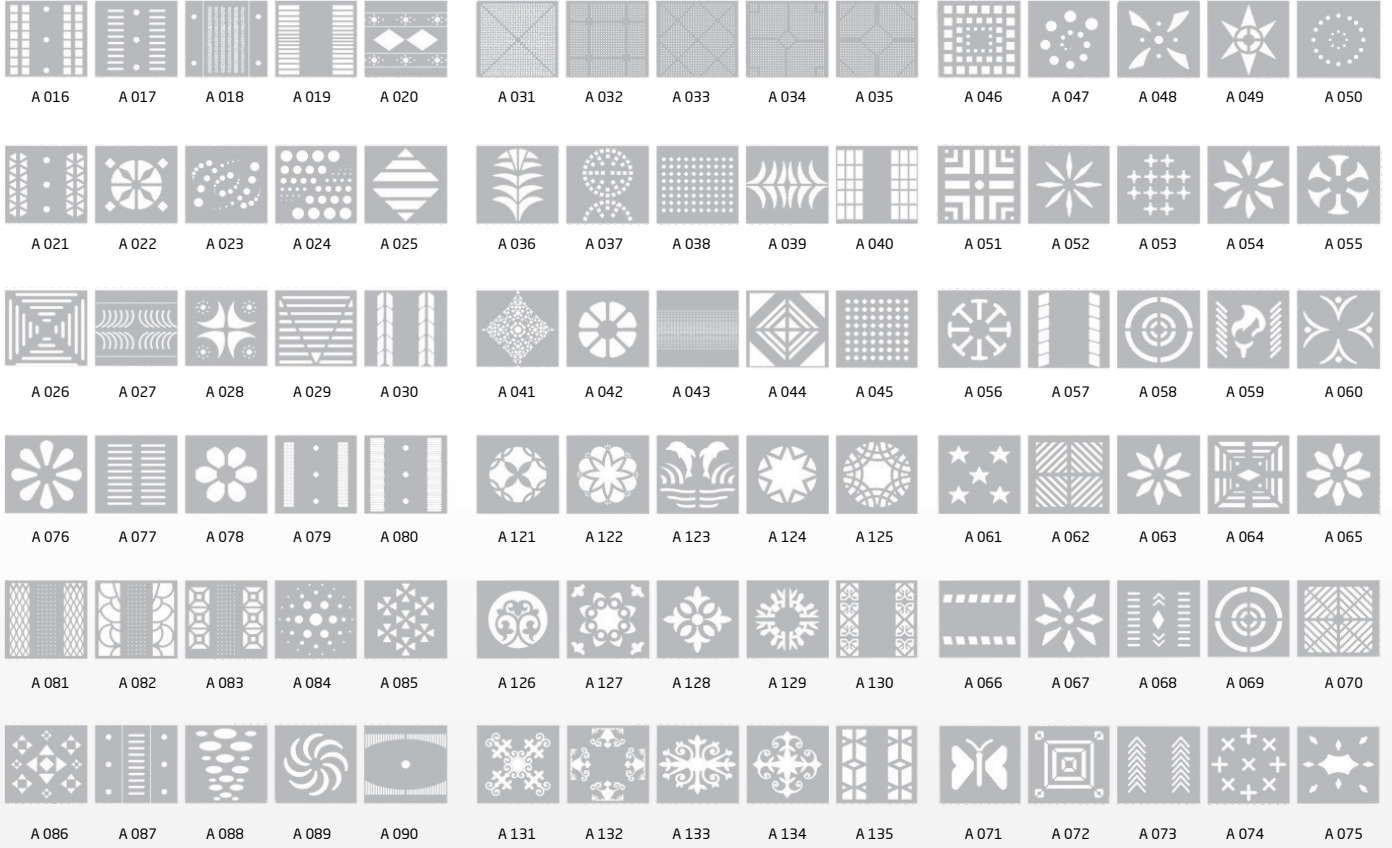

PANAROMİKLER / PANAROMİCS

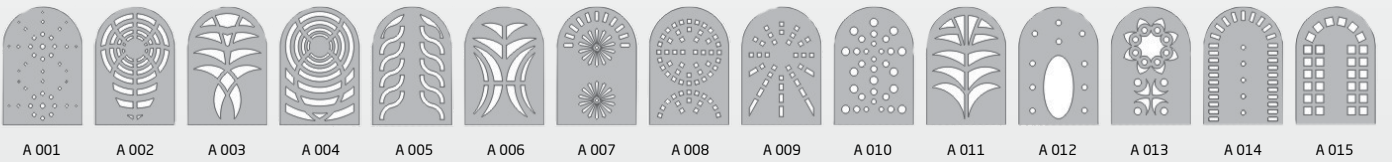

DECOSTEEL SKALA

DECOSTEEL SCALA



Hairlane



Hairlane
Ti-Gold



Hairlane
Ti-Rose



Hairlane
Ti-Black

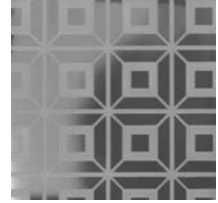

Mirror
CX-41



Mirror
CX-53



Mirror
Ti-Gold CX-53

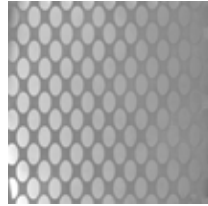

Mirror
CX-58



Mirror
Ti-Gold CX-58



Mirror
CX-82

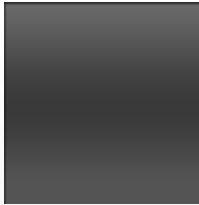

Mirror
Ti-Black



Mirror
Ti-Gold



Mirror
Ti-Rose



Mirror

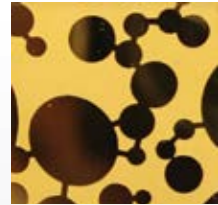

Mirror
Ti-Gold CX-59

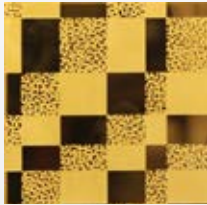

Mirror
Ti-Gold CX-51

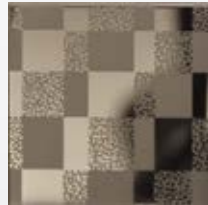

Mirror
CX-51



Mirror
CX-37



Mirror
Ti-Gold CX-37



Mirror
Ti-Gold CX-86

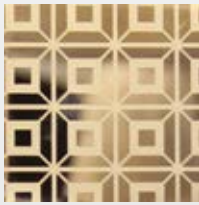

Mirror
Ti-Gold CX-41



YH-E01-150x150



Mirror
Ti-Gold CX-82

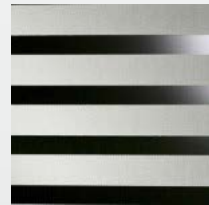

YH-E51-150x150



Mirror
CX-59



Mirror
Ti-Gold CX-20



YH-E58-150x150



ZK-038-150x150



LAMİNANTLAR LAMINATES

Parlak Yüzey

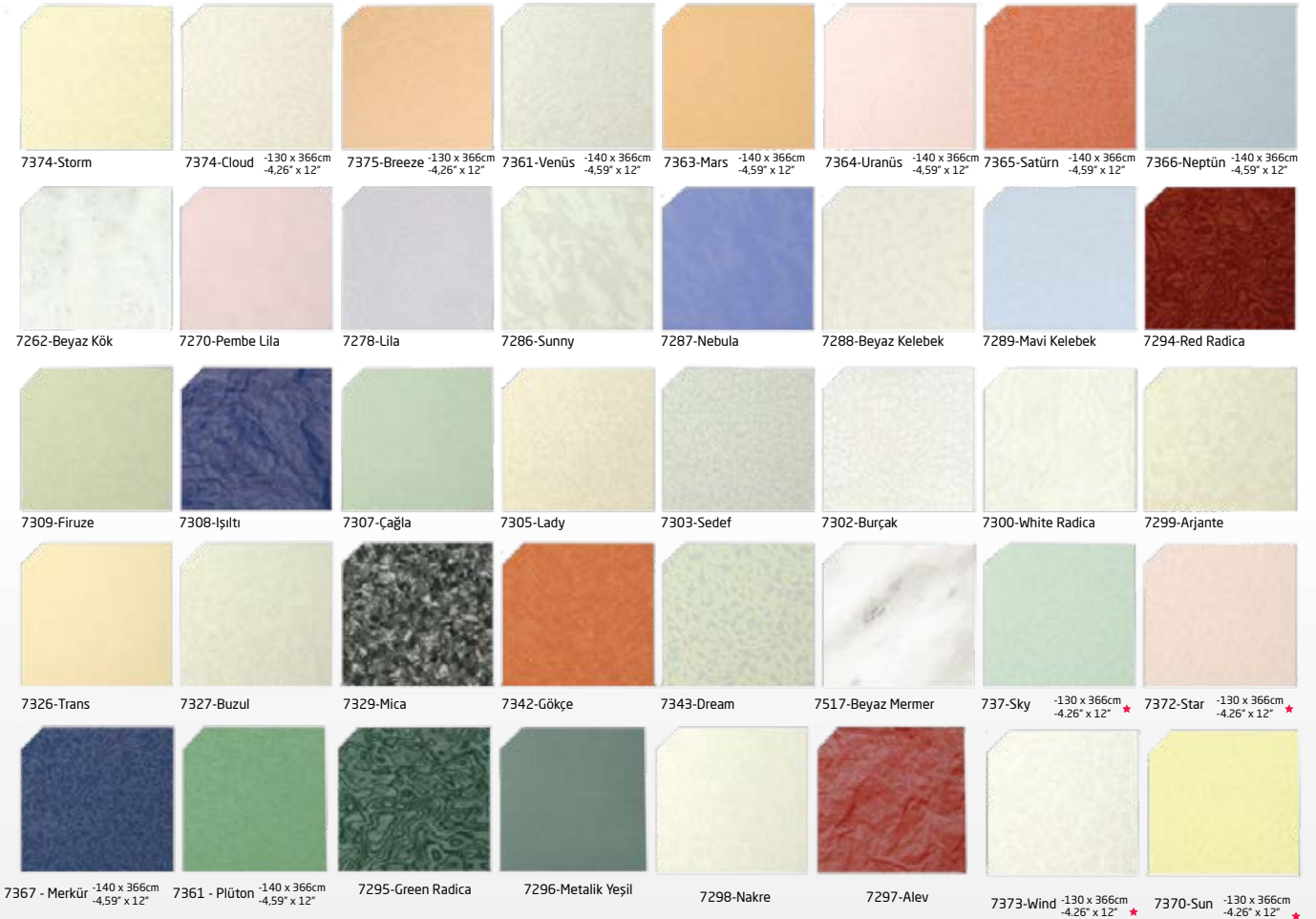

Mat Yüzey



LAMİNANTLAR LAMINATES

Taban Döşeme Granit

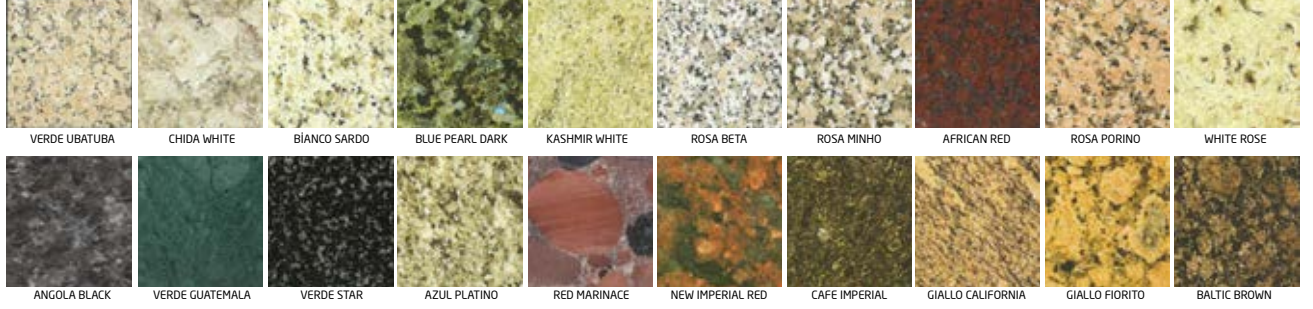

Taban Döşeme PVC

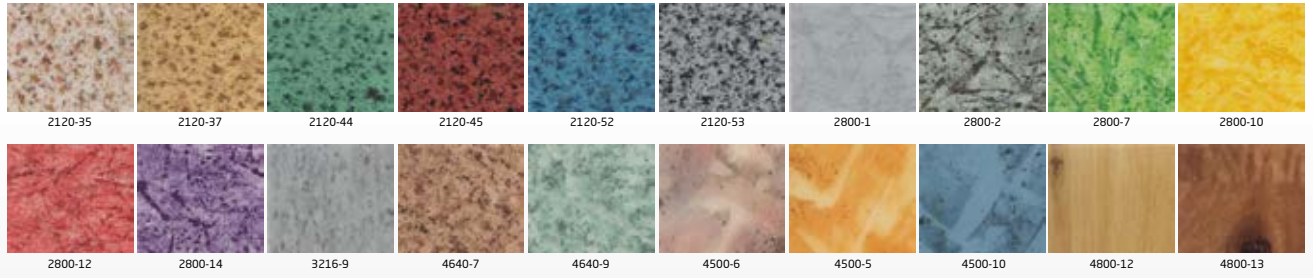

Elektrostatik Boya Skalası

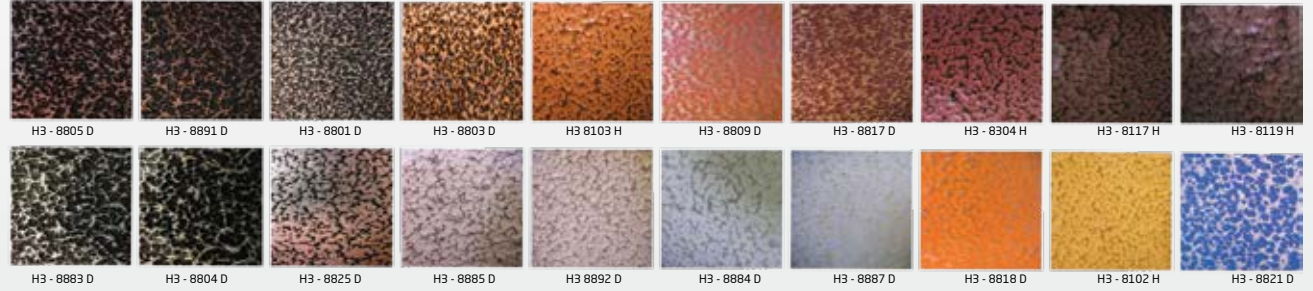

FABRİKADAN GÖRÜNÜM



VIEW OF FACTORY



If Your Target Is To Rise, The Road To Rise Is With **YÜKSELİŞ...**

KABİN İSKELETLERİ

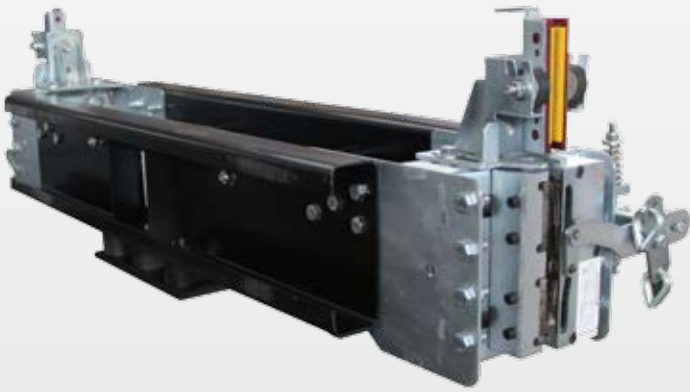
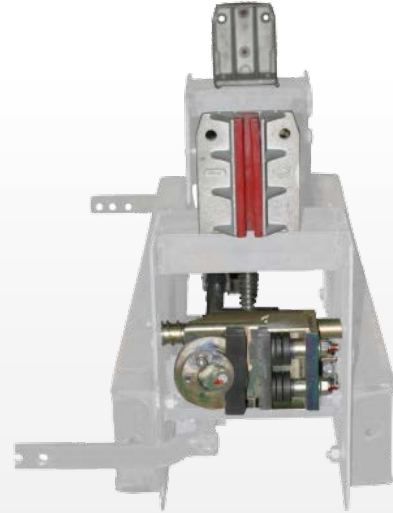



CAR FRAMES

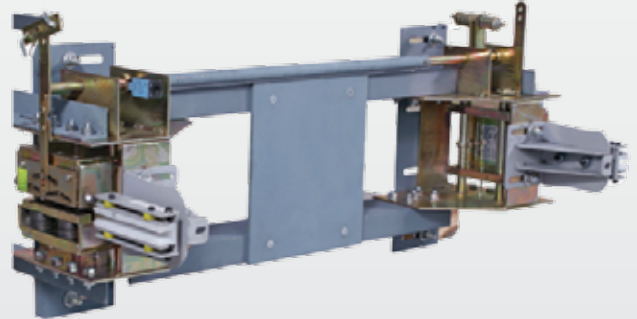
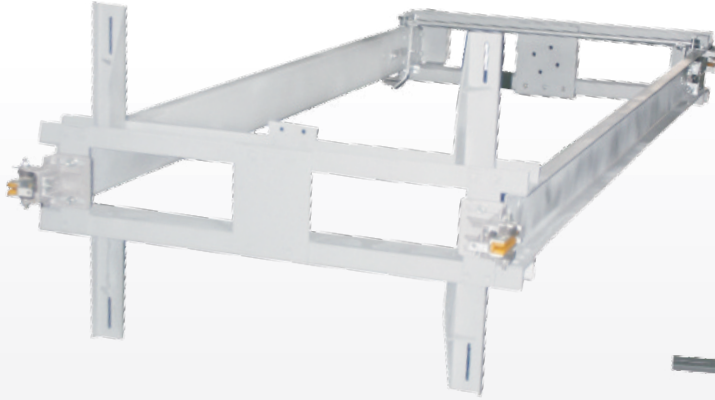

TAM OTOMATİK MERKEZİ VE TELESKOPIK KAT VE KABİN KAPILARI FULL AUTOMATIC CENTRAL AND TELESCOPIC LANDING-CABIN DOORS



TAM OTOMATİK MERKEZİ VE TELESKOPIK KAT VE KABİN KAPILARI FULL AUTOMATIC CENTRAL AND TELESCOPIC LANDING-CABIN DOORS



TAM OTOMATİK MERKEZİ VE TELESKOPIK KAT VE KABİN MEKANİZMALARI FULL AUTOMATIC CENTRAL AND TELESCOPIC LANDING-CABIN MECHANISMS

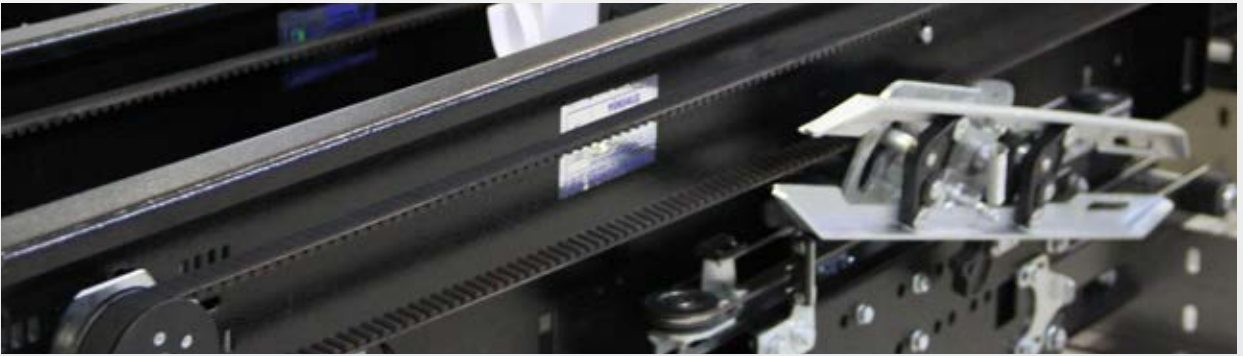
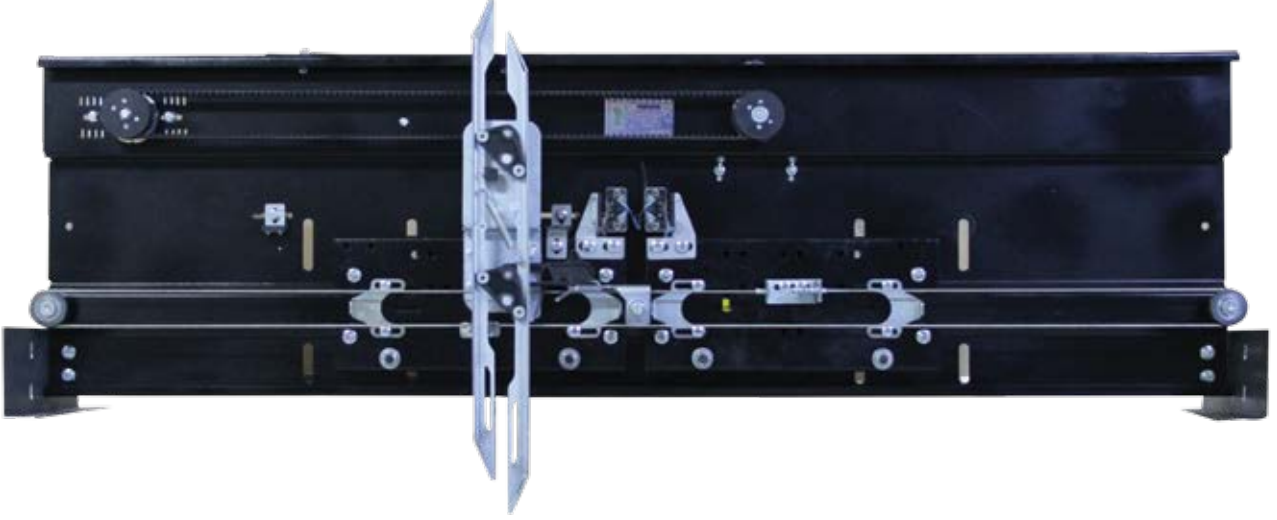

TAM OTOMATİK MERKEZİ VE TELESKOPIK KAT VE KABİN MEKANİZMALARI FULL AUTOMATIC CENTRAL AND TELESCOPIC LANDING-CABIN MECHANISMS







If Your Target Is To Rise, The Road To Rise Is With **YÜKSELİŞ...**



DOKUNMATİK BUTONLAR

TOUCH BUTTONS

- Kapasitif algılama teknolojisi / *Capacitive sensing technology*
- Dokunmatik Kabin-Kat Butonları / *Glass touch-operated cabin-
Landing operation panels*
- Güvenilir, dayanıklı ve uzun ömür / *Safe, durable and long-lasting*
- Seri haberleşme sistemi / *Serial communication system*
- Montaj, kablolama, işçilikte işlem kolaylığı ve düşük maliyetler / *Installation, cabling, processing simplicity and low maintenance costs.*
- Servis ve bakım kolaylığı / *Service and Maintenance simplicity*
- Standart AÇ-KAPA-FAN-DİAFON-ALARM butonları / *Standard*
- SWITCH ON-OFF-FAN-ENTRYPHONE-ALARM Buttons
- Aşırı Yük - Servis Dışı - Yangın-Alarm ikaz ledleri / *Overload, Out of Service, Fire, Alarm Warning Leds*
- Dot Matrix-7 Segment Display-LCD-TFT gösterge seçenekleri / *Dot Matrix-7 Segment Display- LCD-TFT Indicator options*



TFT GÖSTERGELER

TFT DISPLAYS

- 800x480 piksel 7 inç, renkli TFT ekran
Video gösterimi
- Yüksek kalitede müzik çalabilme
- Durak yazıları, durak resimleri, yön okları, logo, arkaplan resimleri ve sinyal göstergelerini (aşırı yük, servis dışı, yangın, acil kurtarma vs.) gösterebilme.
- Arkaplan resimlerinin ayarlanan süre ile değiştirilebilmesi
- Tarih - Saat göstergeleri
- Kullanıcı dostu görsel tasarım programı ile esnek ekran tasarımı imkanı
- Yatay ve dikey konumda çalışabilme
(tasarıma göre)
- SD kart ile programlanabilme. Tasarımınızı SD karta kopyalayıp LiftMedia'ya taktığınızda kullanıma hazır hale gelecektir.
Ürüne dahil SD kart ile saatlerce müzik ve video kaydedebilme. İsteğe göre SDHC kart takılarak kapasite genişletme imkanı
- Türkçe ve İngilizce dil seçenekleri
- 800X480 Pixel 7 inch, colorful TFT screen
Video presentation
- Music player with high quality
- Screen that displays floor numbers and pictures, direction arrows, logo, background pictures, signal indicators (Overload, Out of Service, Fire, Emergency Rescue e.t.c.).
- Changing the background pictures within adjusted period.
- Date - Time Indicators
- Flexible screen design possibility with user-friendly Visual Design Program
- Ability to operate in both vertical and horizontal positions, according to the design.
- Option to be programmed with SD card. If you copy your design to SD card and insert it to Liftmedia, your design will be displayed on the screen. Music and video can be downloaded on SD cart as well, or can already be included in the product. The possibility of adding SDHC card, if capacity expansion is required.
- Turkish and English language options





SHOWROOM GENEL GÖRÜNÜM





SHOWROOM GENERAL VIEW



If Your Target Is To Rise, The Road To Rise Is With YÜKSELİŞ...

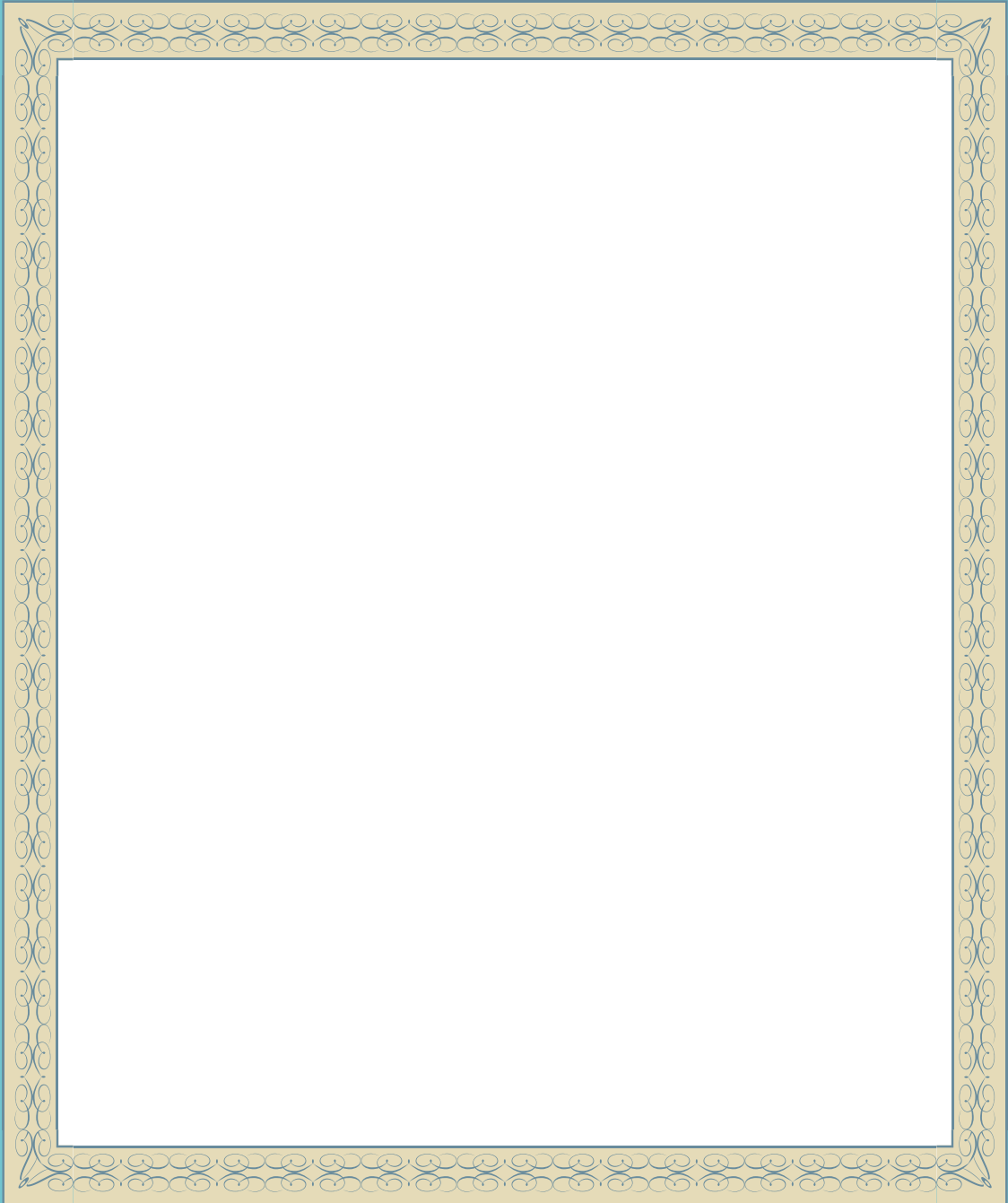



YÜKSELİŞ ASANSÖR

San. Tic. Ltd. Şti.

Showroom: İvedik Organize Sanayi Bölgesi Arı San.
Sitesi 29. Cd. 708. Sokak No: 25-27 Ankara
Tel: 0 312 395 20 62
0 312 395 46 82
0 312 395 80 33
Faks: 0 312 395 20 76

Fabrika: İstanbul yolu 25.km Aksoy Caddesi No:12
Sarayköy - Kazan / Ankara / Türkiye
Tel: 0 312 815 52 05-06
0 312 815 47 85-86
Faks: 0 312 815 52 07

info@yukselesasansor.com.tr
zafer@yukselesasansor.com.tr

www.yukselesasansor.com.tr
www.yukselesasansor.tc



KOSGEB

www.kosgeb.gov.tr

Basım Tarihi: 20.03.2013
Basım Yeri : Grafizm Reklam
Basım Adedi: 3000 Adet

Grafizm Reklam ve Tanıtım Hizmetleri
www.grafizm.com • (312) 341 76 57

Kosgeb Destekli
Basılmıştır.